

LSD diffusori lineari settorizzate



MADEL®

I diffusori lineari della serie **LSD** sono stati progettati per combinare il fattore estetico con le prestazioni tecniche. Si possono sia montare nei contro-soffitti sia direttamente appendere al soffitto.

È possibile ottenere una linea continua dei diffusori, parte attiva parte inattiva, senza interrompere la continuità estetica.

Adatti per mandata e ripresa.

Mediante la regolazione delle alette, orientabili singolarmente ogni 100 mm, si può ottenere una distribuzione orizzontale dell'aria in qualsivoglia direzione, o un lancio verticale, senza variare il volume della stessa.

I diffusori **LSD** permettono una variazione della portata fino al 60% mantenendo stabile la vena d'aria.

Questi diffusori possono essere installati da 2.6 a 4 metri d'altezza con un differenziale di temperatura fino a 12° C.

LSD-AR

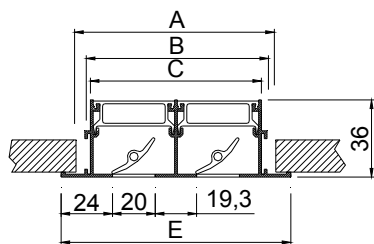

N°VIAS	E	A	B	C
1	68	55	47	40
2	107	95	86	80
3	147	134	125	119
4	186	173	165	159

CLASSIFICAZIONE

- LSD-AR** Diffusore con bordi laterali inclusi, per una lunghezza ≤ 2 m.
- ...-ARI** Diffusore con bordo laterale a sinistra, per una linea > 2 m.
- ...-ARD** Diffusore con bordo laterale a destra, per una linea > 2 m.
- ...-INT** Diffusore senza bordi laterali, per una linea più lunga di 4 m.

LSD-MOD Diffusore modulare.

MATERIALE

Diffusori costruiti in alluminio e alette in PVC nere.

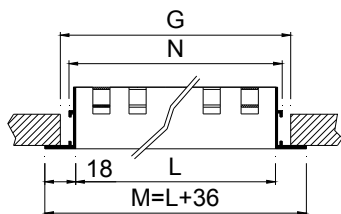

L	M	N	G
500	536	507	516
1000	1036	1007	1016
1200	1236	1207	1216
1500	1536	1507	1516
2000	2036	2007	2016

LSD-MOD

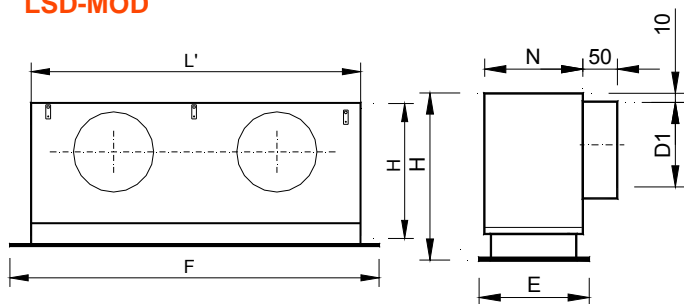

Dim.	F	E	L'	H	D1	N
1-1200x300	1195	295	1145	256	1/158	69
2-1200x300	1195	295	1145	256	1/158	108
3-1200x300	1195	295	1145	296	2/198	147
4-1200x300	1195	295	1145	296	2/198	186
1-1200x600	1195	595	1145	256	1/158	69
2-1200x600	1195	595	1145	256	1/158	108
3-1200x600	1195	595	1145	296	2/198	147
4-1200x600	1195	595	1145	296	2/198	186
1-1350x335	1345	330	1345	256	1/158	69
2-1350x335	1345	330	1345	256	1/158	108
3-1350x335	1345	330	1345	296	2/198	147
4-1350x335	1345	330	1345	296	2/198	186
1-1350x675	1345	670	1345	256	1/158	69
2-1350x675	1345	670	1345	256	1/158	108
3-1350x675	1345	670	1345	296	2/198	147
4-1350x675	1345	670	1345	296	2/198	186

A90/LSD

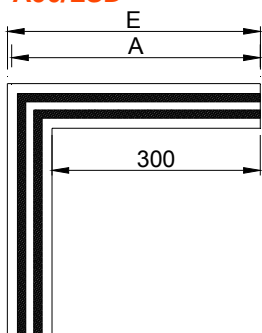

N°VIAS	E	A
1	368	358
2	407	397
3	447	437
4	486	476

LSD-AR + PLSD...-R

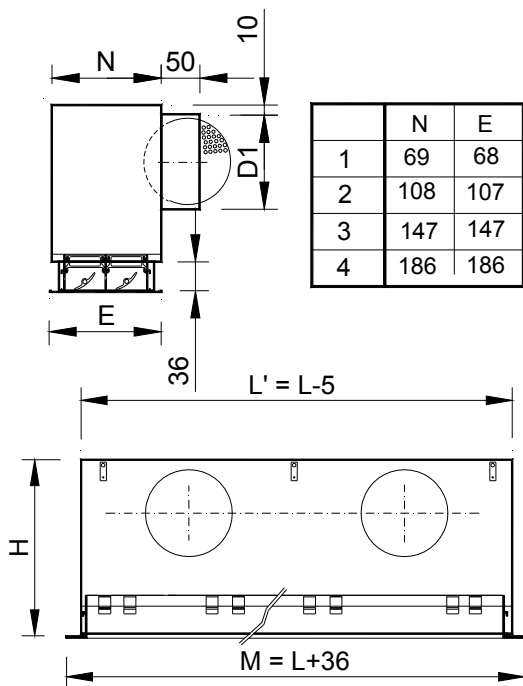

	N	E
1	69	68
2	108	107
3	147	147
4	186	186

	L ≤ 0,5		L ≤ 1		L ≤ 1,2		L ≤ 1,5		L ≤ 2	
	H	D1	H	D1	H	D1	H	D1	H	D1
1	256	1/158	256	1/158	256	1/158	256	1/158	256	2/158
2	256	1/158	256	1/158	256	1/158	256	2/158	256	2/158
3	296	1/198	296	1/198	296	2/198	296	2/198	296	2/198
4	296	1/198	296	1/198	296	2/198	296	2/198	296	2/198

ACCESSORI ACCOPPIABILI

A90/LSD Diffusore inattivo senza bordi, forma un angolo di 90°.

PLSD Plenum con connessione circolare laterale. Con staffe per essere appeso al soffitto. Costruito in acciaio zincato.

...-R Plenum con regolatore di portata nel collo di connessione.

.../AIS/ Plenum isolato termoacusticamente mediante una schiuma con un coefficiente di conduttività termica di 0.04 w/mk. Tale schiuma risponde alle seguenti norme di resistenza al fuoco:

UNE 23-727 M2

NFP 92-501 M2

DIN 4102 M2

SISTEMI DI FISSAGGIO

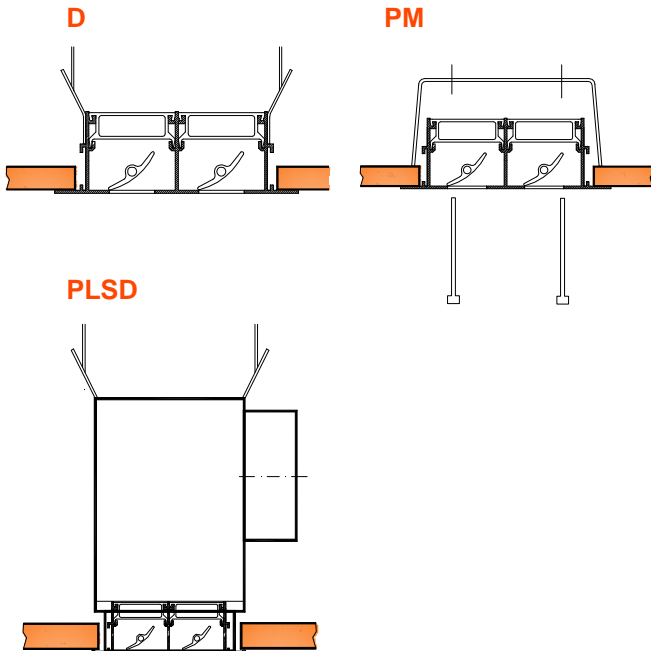

(D) Sospensione del diffusore al soffitto mediante staffe per LSD o LSD+PLSD.

(PL) Connessione al plenum PLSD+PML mediante viti e sospensione al soffitto. Questo sistema semplifica e facilita il montaggio e lo smontaggio del diffusore al plenum.

(PM) Ponte di montaggio per installazione in contro-soffitto.

FINITURE

- AA** Anodizzato color argento opaco.
- M9016** Verniciato bianco simile RAL 9016.
- R9010** Verniciato color bianco RAL 9010.
- RAL...** Verniciato altri colori RAL.
- .../AB/** Alette in PVC bianco.

SPECIFICHE PER CAPITOLATO

Fornitura e posa in opera diffusore lineare a feritoia con alette deflettrici settorizzate serie **LSD-AR+PLSD-R AA 1x558**, costruito in alluminio e anodizzato color argento opaco **AA**. Con plenum con connessione circolare laterale e regolatore di portata nel collo. Marca **MADEL**.

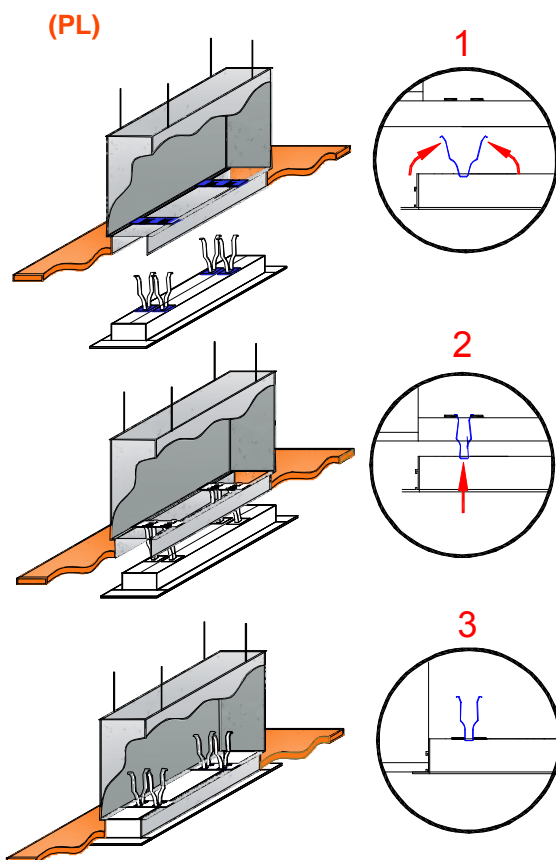

LSD

VELOCIDAD RECOMENDADAS.

VIAS	Vmin (m/s)	Vmax (m/s)
1	2.5	4.5
2	2.5	4.5
3	2.5	4
4	2.5	4

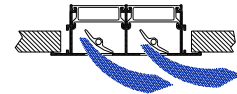
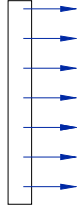

VELOCIDAD LIBRE, PERDIDA DE CARGA Y POTENCIA SONORA, ALCANCE CON EFECTO TECHO: 1 DIRECCIÓN.
LSD-AR + PLSD

SECCION LIBRE DE SALIDA DEL AIRE (m2).

	0.5 m	1 m	1.5 m	2 m
1	0.0043	0.0087	0.013	0.0174
2	0.0087	0.0174	0.0261	0.0348
3	0.013	0.0261	0.0391	0.0522
4	0.0172	0.0348	0.052	0.0696

VALORES DE CORRECCION PARA DPT Y Lwa1.
LSD-AR + PLSD-R

	0.5 m			1 m			1.5 m			2 m		
	100%	50%	0%	100%	50%	0%	100%	50%	0%	100%	50%	0%
1 Dpt	0.95	2.35	3.15	1	1.4	2.2	1	1.4	2.2	1.1	2.5	3.3
1 Lwa1	-6	-3	-3.6	0	0.8	0.4	+1.2	+1.9	+1.4	-2	-	-1.6
2 Dpt	0.98	2.48	3.25	1	1.5	2.3	1	1.5	2.3	1.2	2.7	3.5
2 Lwa1	-4	-3.6	-3.1	0	+0.6	+0.6	+2.3	+3.2	+3.1	0	+1	+1.2
3 Dpt	0.96	2.26	3.36	1	1.3	2.4	1	1.3	2.4	1.3	2.4	3.5
3 Lwa1	-7	-6	-6	0	+0.9	+0.5	-2.7	-2.6	-2.7	-1.4	-1.1	-1.1
4 Dpt	0.95	2.35	3.05	1	1.4	2.1	1	1.4	2.1	1.1	2.5	3.2
4 Lwa1	-3.4	-1.4	-2.5	0	+1.5	+1.2	-1.8	-1.1	-1.2	-1.7	-1	-1.1

$$Dpt1 = Kp \times Dpt$$

$$Lwa1 = Lwa + Kf$$

FACTOR DE CORRECCION DEL ALCANCE KL

	0.5 m	1 m	1.5 m	2 m
1	0.71	1	1.07	1.14
2	0.73	1	1.09	1.15
3	0.74	1	1.11	1.2
4	0.75	1	1.25	1.25

$$AL'02 = Kl \times AL02$$

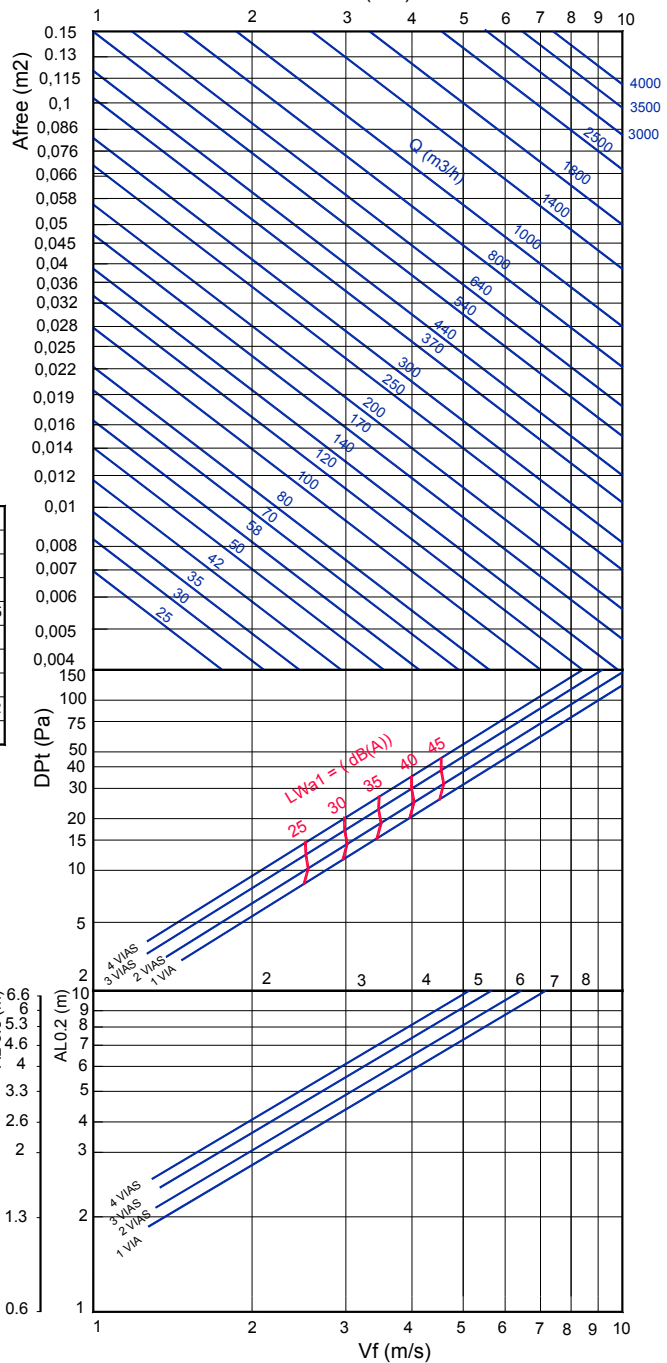
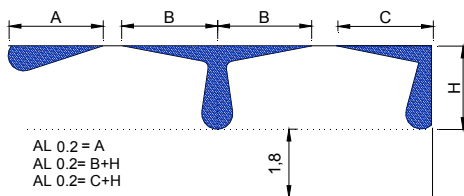

Nota: En MadelMedia Espectro por banda de octava en Hz.

LSD

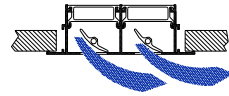

FACTOR DE CORRECCION DE LA DIFUSIÓN VERTICAL (bv) PARA DT (-).

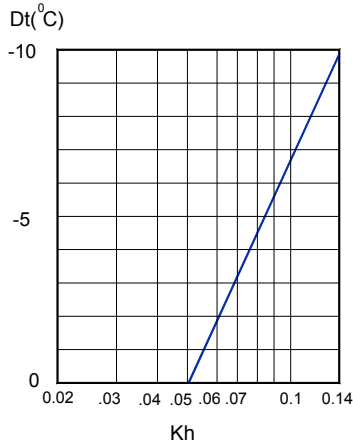

Kh = Factor de corrección de la difusión vertical.

FACTOR DE CORRECCION DEL ALCANCE (L0.2) DT (-).

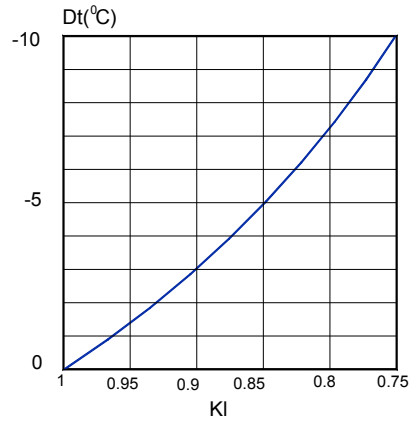

Kl = Factor de corrección del alcance.

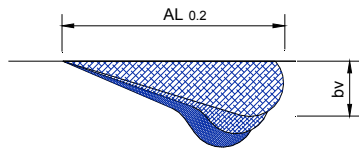

$$bv = Kh \times AL_{0.2}$$

$$AL'_{0.2} (Dt < 0) = Kl \times AL_{0.2}$$

RELACION DE TEMPERATURAS.

$$\frac{Dt_l}{Dtz} = \frac{t_{local} - t_x}{t_{local} - t_{imp}}$$

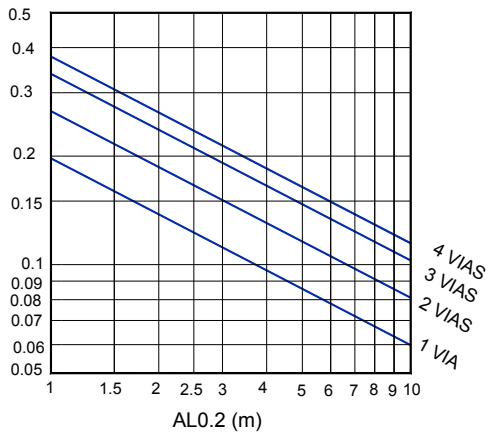

RELACION DE INDUCCION.

$$i = \frac{Q_r}{Q_0} = \frac{Q_{total\ en\ x}}{Q_{de\ impulsión}}$$

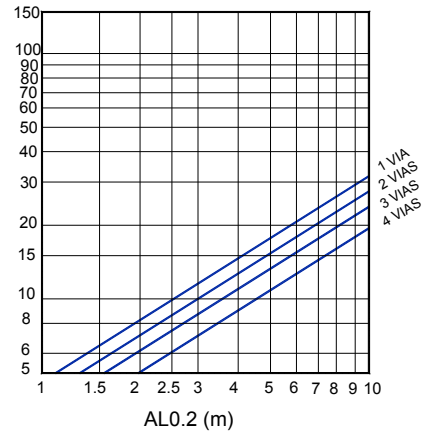

LSD

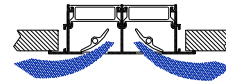

VELOCIDAD RECOMENDADAS.

VIAS	Vmin (m/s)	Vmax (m/s)
2	2.5	4.5
4	2.5	4

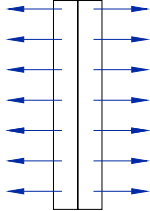

VELOCIDAD LIBRE, PERDIDA DE CARGA Y POTENCIA SONORA, ALCANCE CON EFECTO TECHO: 2 DIRECCIONES.

SECCION LIBRE DE SALIDA DEL AIRE (m2).

	0.5 m	1 m	1.5 m	2 m
1	0.0043	0.0087	0.013	0.0174
2	0.0087	0.0174	0.0261	0.0348
3	0.013	0.0261	0.0391	0.0522
4	0.0172	0.0348	0.052	0.0696

VALORES DE CORRECCION PARA Dpt Y Lwa1.

	0.5 m			1 m			1.5 m			2 m			
	100%	50%	0%	100%	50%	0%	100%	50%	0%	100%	50%	0%	
2	Dpt	0.98	2.48	3.25	1	1.5	2.3	1	1.5	2.3	1.2	2.7	3.5
	Lwa1	-3.9	-3.5	-3	0	+0.6	+0.6	+2.3	+3.2	+3.1	-0.3	+0.9	+1.1
4	Dpt	0.95	2.35	3.05	1	1.4	2.1	1	1.4	2.1	1.1	2.5	3.2
	Lwa1	-3.6	-1.5	-2.5	0	+1.5	+1.1	-1.5	-1.3	-1.4	-1.8	-1.2	-1.3

$Dpt1 = Kp \times Dpt$

$Lwa1 = Lwa + Kf$

FACTOR DE CORRECCION DEL ALCANCE KL

	0.5 m	1 m	1.5 m	2 m
2	0.6	1	1.17	1.3
4	0.767	1	1.2	1.17

$AL'02 = KI \times AL02$

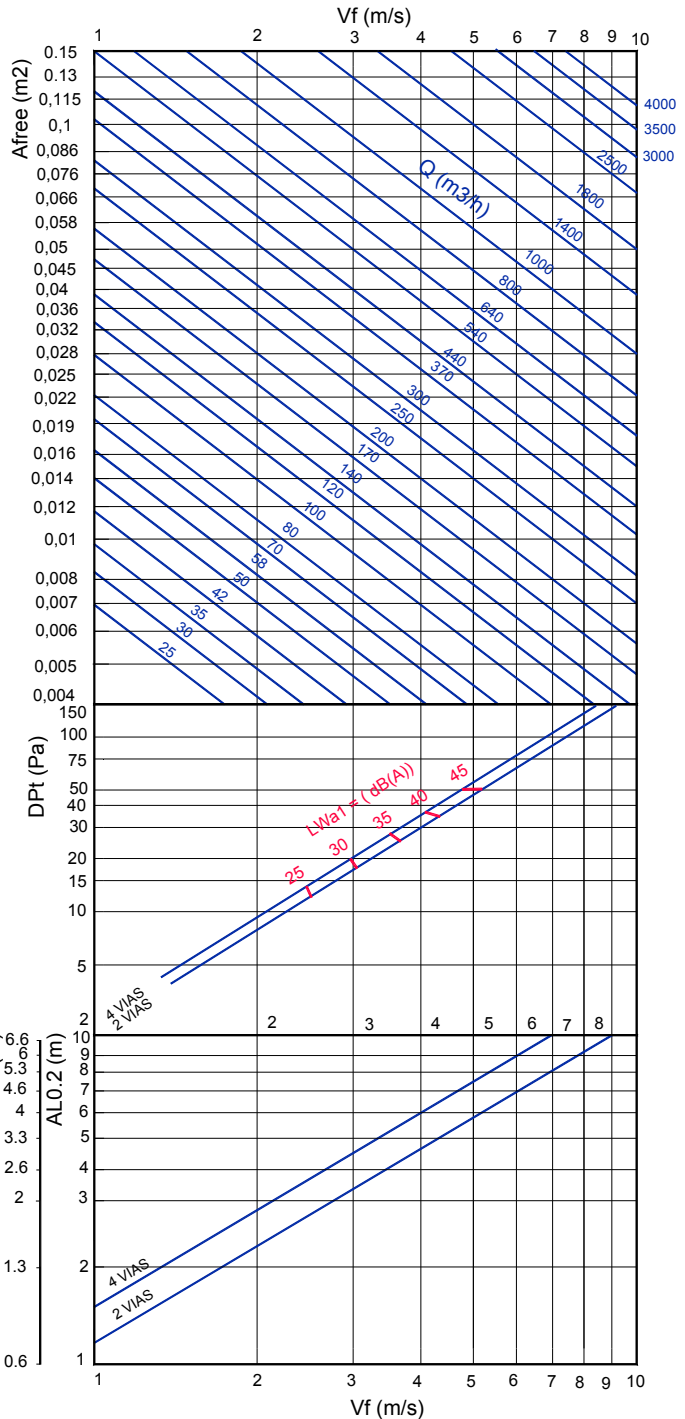
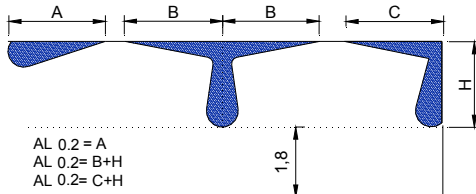

Nota: En MadelMedia Espectro por banda de octava en Hz.

LSD

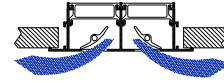

FACTOR DE CORRECCION DE LA DIFUSIÓN VERTICAL (bv) PARA DT (-).

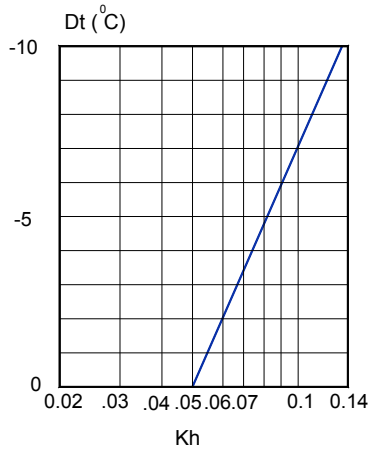

Kh = Factor de corrección de la difusión vertical.

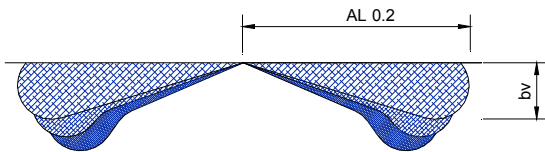

FACTOR DE CORRECCION DEL ALCANCE (L0.2) DT (-).

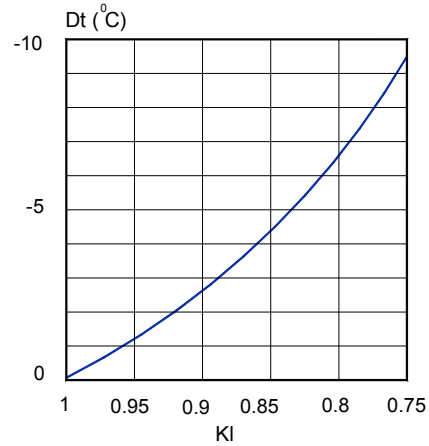

Kl = Factor de corrección del alcance.

$$bv = Kh \times Al_{0.2}$$

$$AL'_{0.2} (Dt < 0) = Kl \times AL_{0.2}$$

RELACION DE TEMPERATURAS.

$$\frac{Dtl}{Dtz} = \frac{t_{local} - t_x}{t_{local} - t_{imp}}$$

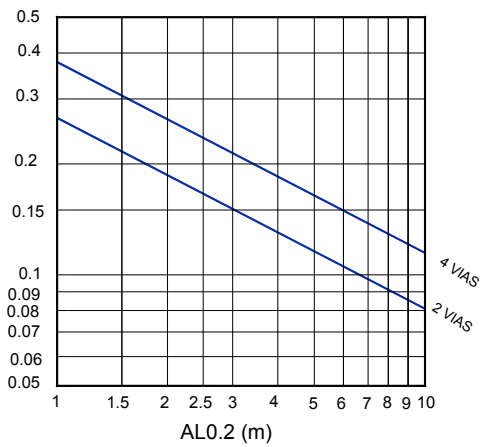

RELACION DE INDUCCION.

$$i = \frac{Q_r}{Q_0} = \frac{Q_{total\ en\ x}}{Q_{de\ impulsión}}$$

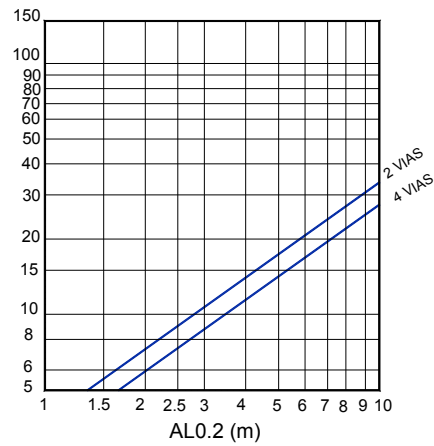

LSD

VELOCIDAD RECOMENDADAS.

VIAS	Vmin (m/s)	Vmax (m/s)
1	2.5	4.5
2	2.5	4.5
3	2.5	4
4	2.5	4

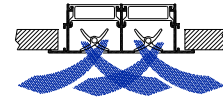
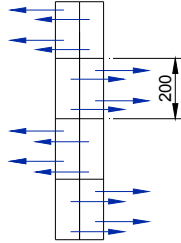

VELOCIDAD LIBRE, PERDIDA DE CARGA Y POTENCIA SONORA, ALCANCE CON EFECTO TECHO: 2 DIRECCIONES.

SECCION LIBRE DE SALIDA DEL AIRE (m2).

	0.5 m	1 m	1.5 m	2 m
1	0.0043	0.0087	0.013	0.0174
2	0.0087	0.0174	0.0261	0.0348
3	0.013	0.0261	0.0391	0.0522
4	0.0172	0.0348	0.052	0.0696

VALORES DE CORRECCION PARA DPT Y Lwa1.

	0.5 m			1 m			1.5 m			2 m			
	100%	50%	0%	100%	50%	0%	100%	50%	0%	100%	50%	0%	
1	Dpt	0.95	2.35	3.15	1	1.4	2.2	1	1.4	2.2	1.1	2.5	3.3
	Lwa1	-6	-3	-3.7	0	+0.8	+0.4	+1	+1.7	+1.2	-2.1	-0.4	-1.9
2	Dpt	0.98	2.48	3.25	1	1.5	2.3	1	1.5	2.3	1.2	2.7	3.5
	Lwa1	-3.7	-3.4	-2.9	0	+0.6	+0.6	+2.4	+3.3	+3.2	-0.5	+0.8	+0.9
3	Dpt	0.96	2.26	3.36	1	1.3	2.4	1	1.3	2.4	1.3	2.4	3.5
	Lwa1	-6.9	-6.3	-5.9	0	+0.9	+0.5	-3	-2.9	-3	-1.8	-1.5	-1.6
4	Dpt	0.95	2.35	3.05	1	1.4	2.1	-3	-2.9	-3	1.1	2.5	3.2
	Lwa1	-3.4	-1.6	-2.4	0	+1.6	+1.2	-2	-1.4	-1.5	-2	-1.3	-1.5

$Dpt1 = Kp \times Dpt$

$Lwa1 = Lwa + Kf$

FACTOR DE CORRECCION DEL ALCANCE KL

	0.5 m	1 m	1.5 m	2 m
1	0.82	1	1.2	1.43
2	0.73	1	1.27	1.34
3	0.8	1	1.17	1.22
4	0.9	1	1.14	1.19

$AL'02 = Kl \times AL02$

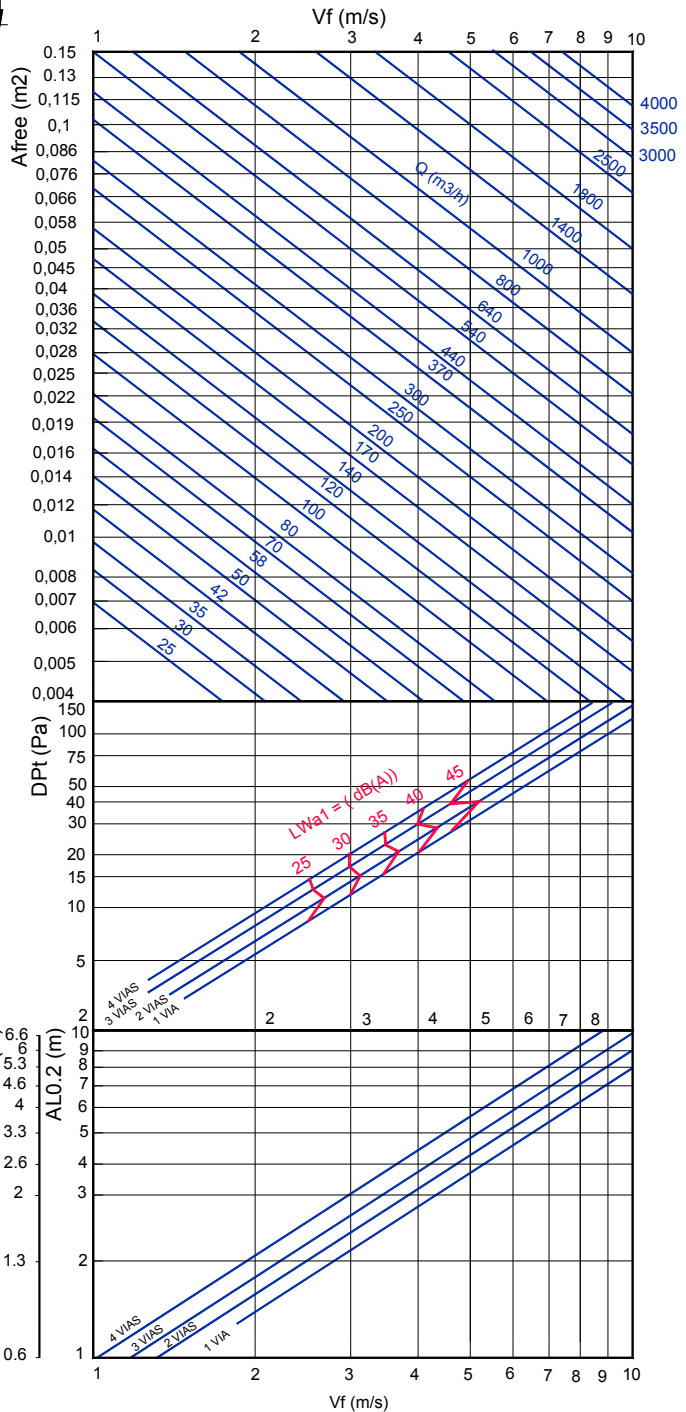
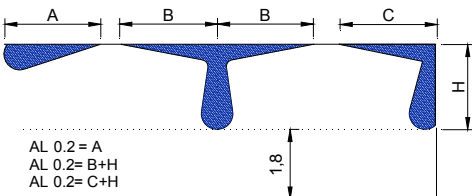

Nota: En MadelMedia Espectro por banda de octava en Hz.

LSD

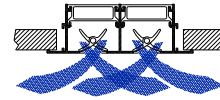

FACTOR DE CORRECCION DE LA DIFUSION VERTICAL (bv) PARA DT (-).

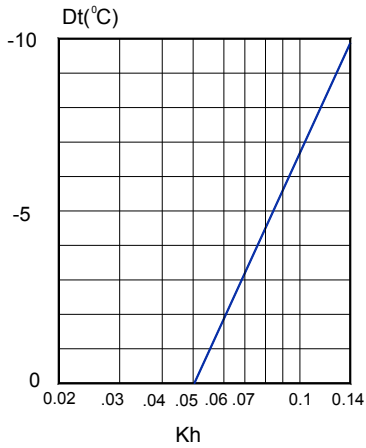

Kh = Factor de corrección de la difusión vertical.

FACTOR DE CORRECCION DEL ALCANCE (L0.2) DT (-).

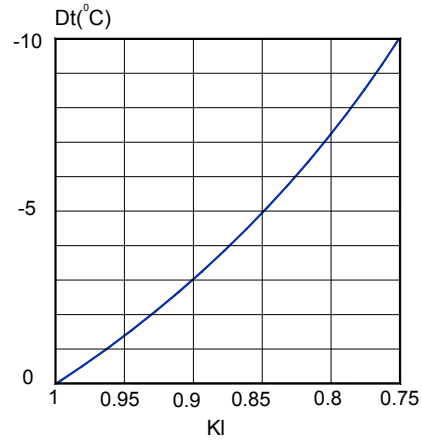

Kl = Factor de corrección del alcance.

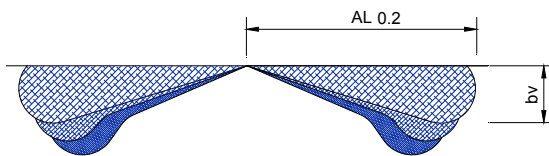

$$bv = Kh \times Al_{0.2}$$

$$AL'_{0.2} (Dt < 0) = Kl \times AL_{0.2}$$

RELACION DE TEMPERATURAS.

$$\frac{Dtl}{Dtz} = \frac{t \text{ local} - t_x}{t \text{ local} - t_{imp}}$$

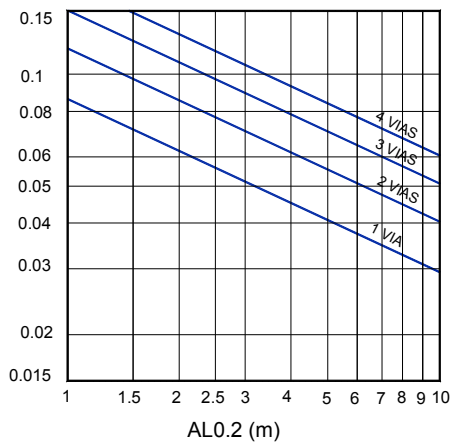

RELACION DE INDUCCION.

$$i = \frac{Q_r}{Q_0} = \frac{Q \text{ total en } x}{Q \text{ de impulsión}}$$

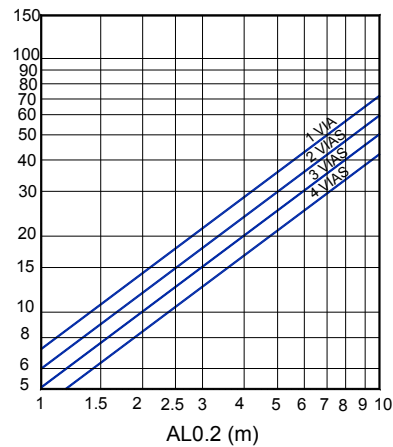

LSD

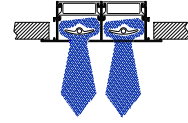

VELOCIDAD RECOMENDADAS.

VIAS	Vmin (m/s)	Vmax (m/s)
1	2.5	4.5
2	2.5	4.5
3	2.5	4
4	2.5	4

VELOCIDAD LIBRE, PERDIDA DE CARGA Y POTENCIA SONORA:
IMPULSION VERTICAL.

SECCION LIBRE DE SALIDA DEL AIRE (m2).

	0.5 m	1 m	1.5 m	2 m
1	0.0043	0.0087	0.013	0.0174
2	0.0087	0.0174	0.0261	0.0348
3	0.013	0.0261	0.0391	0.0522
4	0.0172	0.0348	0.052	0.0696

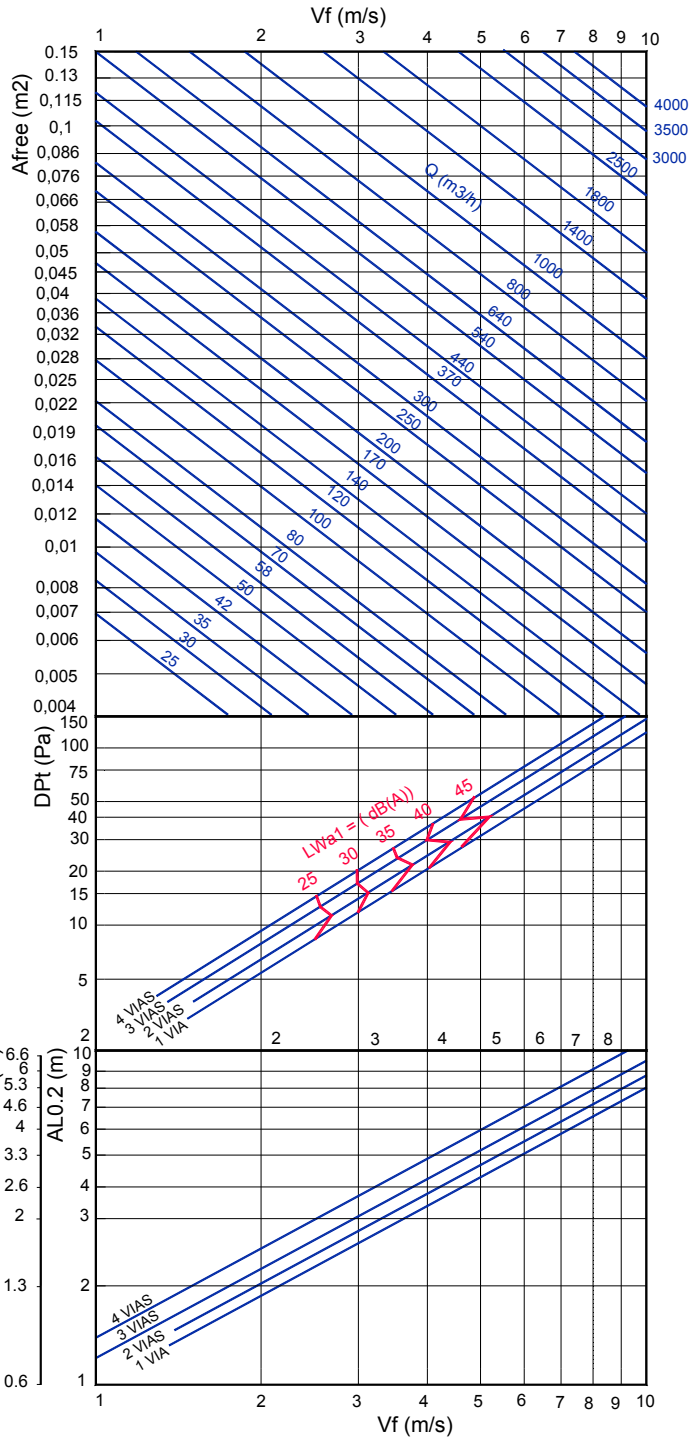

VALORES DE CORRECCION PARA Dpt Y Lwa1.

	0.5 m			1 m			1.5 m			2 m			
	100%	50%	0%	100%	50%	0%	100%	50%	0%	100%	50%	0%	
1	Dpt	0.95	2.35	3.15	1	1.4	2.2	1	1.4	2.2	1.1	2.5	3.3
	Lwa1	-6.1	-3.1	-3.6	0	+0.8	+0.4	+0.9	+1.6	+1	-2.1	-0.5	-1.9
2	Dpt	0.98	2.48	3.25	1	1.5	2.3	1	1.5	2.3	1.2	2.7	3.5
	Lwa1	-3.8	-3.4	-2.9	0	+0.6	+0.6	+2.4	+3.3	+3.2	-0.3	+0.9	+1.1
3	Dpt	0.96	2.26	3.36	1	1.3	2.4	1	1.3	2.4	1.3	2.4	3.5
	Lwa1	-7	-6.3	-6	0	+0.9	+0.5	-2.8	-2.8	-2.9	-1.5	-1.2	-1.3
4	Dpt	0.95	2.35	3.05	1	1.4	2.1	1	1.4	2.1	1.1	2.5	3.2
	Lwa1	-3.4	-1.5	-2.5	0	+1.6	+1.2	-1.9	-1.3	-1.4	-1.9	-1.2	-1.3

$DPT1 = Kp \times DPT$

$Lwa1 = Lwa + Kf$

FACTOR DE CORRECCION DEL
ALCANCE KL

	0.5 m	1 m	1.5 m	2 m
1	0.7	1	1.1	1.2
2	0.72	1	1.15	1.25
3	0.72	1	1.12	1.2
4	0.74	1	1.25	1.25

$ALv \cdot 0.2 = Kl \times ALv \cdot 02$

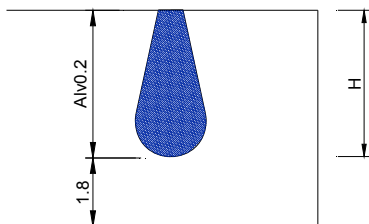

Nota: En MadelMedia Espectro por banda de octava en Hz.

LSD

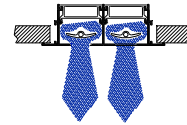

FACTOR DE CORRECCION DEL ALCANCE VERTICAL (Alv 0,2) DT(+).

	D T(+5)	DT(+10)
1 VIA	0.75	0.64
2 VIAS	0.76	0.65
3 VIAS	0.77	0.66
4 VIAS	0.8	0.64

DT = T impulsión - T ocal.

EJEMPLO:

LSD 2VIAS x 2m
 Afree = 0.0348 m².
 Vf = 3.1 m/s.
 ALv 0,2 = 2.9 m.
 ALv'02 = 1.1 x 2.9 = 3.19 m.
 DT(+5) = 0.76 x 3.19 = 2.42 m.
 DT (+10) = 0.65 x 3.19 = 2.07m.

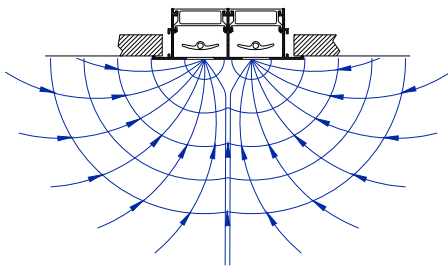

VELOCIDAD RECOMENDADAS.

VIAS	Vmin (m/s)	Vmax (m/s)
1	2	3.5
2	2	3.5
3	2	3
4	2	3

SECCION LIBRE DE SALIDA DEL AIRE (m²).

	0.5 m	1 m	1.5 m	2 m
1	0.0043	0.0087	0.013	0.0174
2	0.0087	0.0174	0.0261	0.0348
3	0.013	0.0261	0.0391	0.0522
4	0.0172	0.0348	0.052	0.0696

VALORES DE CORRECCION PARA Dpt Y Lwa1.

	0.5 m			1 m			1.5 m			2 m			
	100%	50%	0%	100%	50%	0%	100%	50%	0%	100%	50%	0%	
1	Dpt	0.88	2.28	3	1	1.4	2.2	1.3	2.7	3.5	1.5	2.9	3.7
	Lwa1	-	3	5	-	4	7	-	3	5	-	3	7
2	Dpt	0.85	2.35	3.15	1	1.5	2.3	1.4	2.9	3.7	1.66	3.16	3.96
	Lwa1	-	3	5	-	4	7	-	4	7	-	3	8
3	Dpt	0.8	2.1	3.2	1	1.3	2.4	1.2	2.5	3.6	1.4	2.7	3.8
	Lwa1	-	4	5	-	5	8	-	5	8	-	4	8
4	Dpt	0.7	2.1	2.8	1	1.4	2.1	1.3	2.7	3.4	1.5	2.9	3.6
	Lwa1	-	4	5	-	4	8	-	5	8	-	4	8

$Dpt1 = Kp \times Dpt$

$Lwa1 = Lwa + Kf$

VELOCIDAD LIBRE, PERDIDA DE CARGA Y POTENCIA SONORA.

