

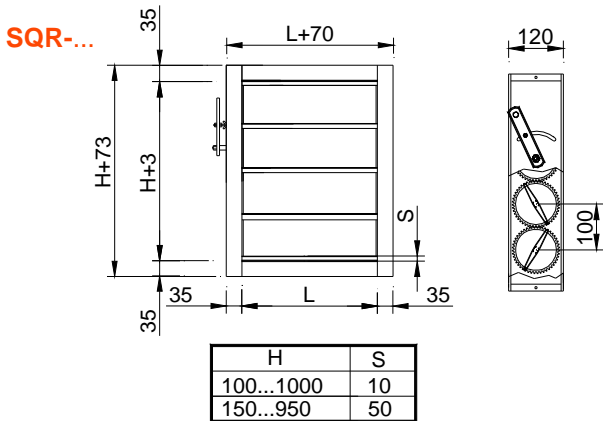

SQR clapets de réglage rectangulaires

MADEL®

Les volets de la série **SQR** ont été conçus pour régler le débit et la pression dans les installations d'air, ventilation et chauffage. Lames opposées de 100 mm.



CLASSIFICATION

SQR-EH Clapet à ailettes à profil romboïde, parallèles à la dimension majeure (cote L).

SQR-EV Clapet à ailettes à profil romboïde, parallèles à la dimension plus petite (cote H).

SQR-CC Clapet carré à ailettes à profil romboïde et connexions circulaires.

.../MA/ Clapet à commande manuelle.

.../MO/ Clapet avec axe pour motoriser.

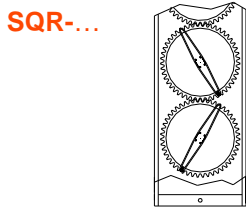

MATÉRIAUX

Cadre en aluminium extrudé en forme de « U ». Ailettes aérodynamiques en aluminium extrudé, avec un joint mousse aux extrémités. Plaque de protection du système de transmission en acier galvanisé. Coussinets en acier de grande résistance. Transmission par engrenage polyamide-6, placé à l'extérieure du registre pour éviter de la saleté dans la transmission.

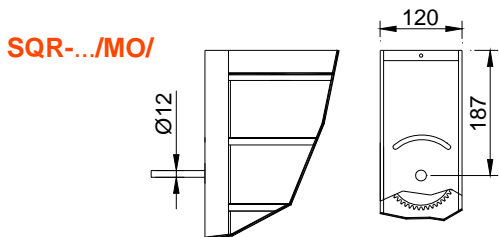
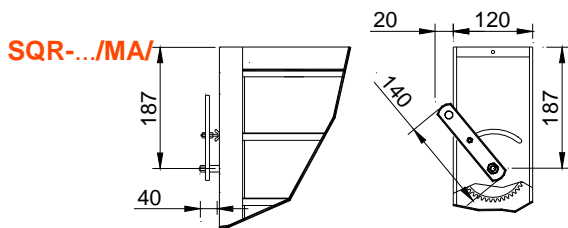

SQR-CC

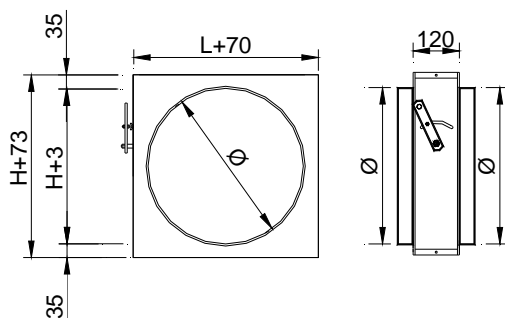

SIEMENS



ON/OFF actuators

- GSD141.1A-24v Siemens actuator On/Off 2N
- GSD141.1A-230v Siemens actuator On/Off 2N
- GDB141.1E-24v Siemens actuator On/Off 5N
- GDB141.1E-230v Siemens actuator On/Off 5N
- GLB141.1E-24v Siemens actuator On/Off 10N
- GLB341.1E-230v Siemens actuator On/Off 10N
- GEB141.1E -24v Siemens actuator On/Off 20N
- GEB341.1E -230v Siemens actuator On/Off 20N
- LM24A Belimo actuator On/Off 5N
- LM230A Belimo actuator On/Off 5N
- NM24A Belimo actuator On/Off 10N
- NM230A Belimo actuator On/Off 10N



ON/OFF actuators with switches device

- GDB146.1E-24v Siemens actuator On/Off 5N, 2FC
- GDB346.1E-230v Siemens actuator On/Off 5N, 2FC
- GLB146.1E-24v Siemens actuator On/Off 10N, 2FC
- GLB346.1E-230v Siemens actuator On/Off 10N, 2FC
- GEB146.1E-24v Siemens actuator On/Off 15N, 2FC
- GEB346.1E-230v Siemens actuator On/Off 15N, 2FC
- LM24A-S Belimo actuator On/Off 5N, 1FC (*)
- LM230A-S Belimo actuator On/Off 5N, 1FC (*)
- NM24A-S Belimo actuator On/Off 10N, 1FC (*)
- NM230A-S Belimo actuator On/Off 10N, 1FC (*)

** Belimo actuator with end of course switch for 2 contacts.*

BELIMO



ON/OFF actuators with spring return

- GPC121.1A-24v Siemens actuator On/Off 4N
- GPC321.1A-230v Siemens actuator On/Off 4N
- GMA121.1E-24v Siemens actuator On/Off 7N
- GMA321.1E-230v Siemens actuator On/Off 7N
- LF-24 Belimo actuator On/Off 4N
- LF-230 Belimo actuator On/Off 4N
- NFA Belimo actuator On/Off 24-230 VAC, 10N

ON/OFF act. with spring return and switches

- GPC126.1A-24v Siemens actuator On/Off 4N
- GPC326.1A-230v Siemens actuator On/Off 4N
- GMA126.1E-24v Siemens actuator On/Off 7N
- GMA326.1E-230v Siemens actuator On/Off 4N
- LF-24-S Belimo actuator On/Off 4N
- LF-230-S Belimo actuator On/Off 4N
- NFA-S2 Belimo actuator On/Off 24-230 VAC, 10N



Proportional actuators

- GDB161.1E-24v Siemens actuator proportional 5N
- GLB161.1E-24v Siemens actuator proportional 10N
- GEB161.1E-24v Siemens actuator proportional 15N
- LM24A-SR Belimo actuator proportional 5N
- LM230A-SR Belimo actuator proportional 5N
- NM24A-SR Belimo actuator proportional 10N
- NM230A-SR Belimo actuator proportional 10N



Proportional actuators with MODBUS

- GDB111.1E/MO-24v Siemens actuator proportional 5N
- GLB111.1E/MO-24v Siemens actuator proportional 10N
- LM24A-MOD Belimo actuator proportional 5N
- NM24A-MOD Belimo actuator proportional 10N



SÉLECTION DE PUISSANCE DES SERVOMOTEURS

Note: Les clapets / MO / sont livrées avec le servomoteur installé en usine.

L x H mm	actuator N	L x H mm	actuator N	L x H mm	actuator N
200x100	5 N	700x250	5 N	700x600	5 N
300x100	5 N	800x250	5 N	800x600	5 N
400x100	5 N	900x250	5 N	900x600	5 N
500x100	5 N	1000x250	5 N	1000x600	5 N
600x100	5 N	1200x250	5 N	1200x600	5 N
700x100	5 N	1400x250	5 N	1400x600	10 N
800x100	5 N	1600x250	5 N	1600x600	10 N
900x100	5 N	1800x250	5 N	1800x600	10 N
1000x100	5 N	2000x250	5 N	2000x600	10 N
1200x100	5 N	300x300	5 N	700x700	5 N
1400x100	5 N	400x300	5 N	800x700	5 N
1600x100	5 N	500x300	5 N	900x700	5 N
1800x100	5 N	600x300	5 N	1000x700	5 N
2000x100	5 N	700x300	5 N	1200x700	5 N
200x150	5 N	800x300	5 N	1400x700	10 N
300x150	5 N	900x300	5 N	1600x700	10 N
400x150	5 N	1000x300	5 N	1800x700	10 N
500x150	5 N	1200x300	5 N	2000x700	10 N
600x150	5 N	1400x300	5 N	800x800	5 N
700x150	5 N	1600x300	5 N	900x800	5 N
800x150	5 N	1800x300	5 N	1000x800	10 N
900x150	5 N	2000x300	5 N	1200x800	10 N
1000x150	5 N	400x400	5 N	1400x800	10 N
1200x150	5 N	500x400	5 N	1600x800	10 N
1400x150	5 N	600x400	5 N	1800x800	15 N
1600x150	5 N	700x400	5 N	2000x800	15 N
1800x150	5 N	800x400	5 N	900x900	10 N
2000x150	5 N	900x400	5 N	1000x900	10 N
200x200	5 N	1000x400	5 N	1200x900	10 N
300x200	5 N	1200x400	5 N	1400x900	10 N
400x200	5 N	1400x400	5 N	1600x900	15 N
500x200	5 N	1600x400	5 N	1800x900	15 N
600x200	5 N	1800x400	5 N	2000x900	15 N
700x200	5 N	2000x400	5 N	1000x1000	10 N
800x200	5 N	500x500	5 N	1200x1000	10 N
900x200	5 N	600x500	5 N	1400x1000	10 N
1000x200	5 N	700x500	5 N	1600x1000	15 N
1200x200	5 N	800x500	5 N	1800x1000	15 N
1400x200	5 N	900x500	5 N	2000x1000	15 N
1600x200	5 N	1000x500	5 N		
1800x200	5 N	1200x500	5 N	CC	actuator
2000x200	5 N	1400x500	5 N	mm	N
300x250	5 N	1600x500	10 N	400	5 N
400x250	5 N	1800x500	10 N	450	5 N
500x250	5 N	2000x500	10 N	500	5 N
600x250	5 N	600x600	5 N	630	5 N

CONTRÔLE DE TEMPÉRATURE

TF



TF-RC



TF Thermostat à fils à changement mode froid/chaud manuel, pour contrôler la température d'1 zone au moyen de clapets avec servo On/Off.

TF-RC Thermostat via radio à changement mode froid/chaud manuel, pour contrôler la température de 1 zone au moyen de clapets avec servo On/Off.

**CO2-WP
CO2-WR**



RDG 400



RDG 400 Régulateur de température ambiante proportionnel Siemens, 0 ... 10 Vcc aliment. 24vac avec affichage numérique rétroéclairé, sélecteur de confort/eco/arrêt, pour servomoteurs de clapet proportionnels .

CO2-WP Sonde/contoleur murale 24 vdc-vac. Lecture d'affichage LED. Sorties 0-10Vdc. Setpoint 600 - 800 -1000 ppm. Sonde de CO2 proportionnelles (Précisent servo proportionnel)

CO2-D Sonde à conduit 24 vdc-vac avec une sortie 0-10Vdc IP54. Sonde de CO2 proportionnelles (Précisent servo proportionnel)

CO2-D



OS-360



CO2-WC Sonde ambiante murale 24 vdc-vac. Lecture d'affichage LED. Sortie numérique (relais 5A). Setpoint 800 - 1000 -1200 ppm . Sonde de CO2 avec relais (Précisent servo ON / OFF)

OS-360 Capteur de présence par mouvement omnidirectionnel plafonnier pour le contrôle des éléments terminaux HVAC. Alimentation 24 Vac/Vdc. Sortie de contact inverseur configurable.

ACCESSOIRES DE MONTAGE

/FC/ Kit free-cooling pour monter 2 clapets à 90°.

FC

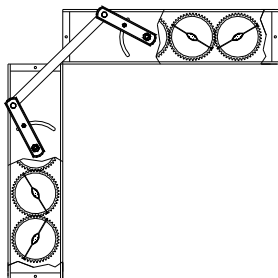

SYSTÈMES DE FIXATION

1) Le cadre du registre à brides est dessiné pour être installé (riveté) dans les gaines ou sur des surfaces planes.

CR Col de connexion plat.

PRESCRIPTION

Fourniture et pose de clapet de réglage de débit pour gaine rectangulaire avec commande manuelle série **SQR-H/MA/ LXH**. construit en aluminium et finition Construite en aluminium naturel et engrenages en polyamide. Marque **MADEL**.

SQR SERIES

BxH (m2) (A face)

H \ B	100	200	300	400	500	600	700	800	900	1000	1100	1200
100	0,01	0,02	0,03	0,04	0,05	0,06	0,07	0,08	0,09	0,1	0,11	0,12
150	0,01	0,03	0,04	0,06	0,07	0,09	0,1	0,12	0,13	0,15	0,16	0,18
200	0,02	0,04	0,06	0,08	0,1	0,12	0,14	0,16	0,18	0,2	0,22	0,24
250	0,02	0,05	0,07	0,1	0,12	0,15	0,17	0,2	0,22	0,25	0,27	0,3
300	0,03	0,06	0,09	0,12	0,15	0,18	0,21	0,24	0,27	0,3	0,33	0,36
350	0,03	0,07	0,1	0,14	0,17	0,21	0,24	0,28	0,31	0,35	0,38	0,42
400	0,04	0,08	0,12	0,16	0,2	0,24	0,28	0,32	0,36	0,4	0,44	0,48
450	0,04	0,09	0,13	0,18	0,22	0,27	0,31	0,36	0,4	0,45	0,49	0,54
500	0,05	0,1	0,15	0,2	0,25	0,3	0,35	0,4	0,45	0,5	0,55	0,6
550	0,05	0,11	0,16	0,22	0,27	0,33	0,38	0,44	0,49	0,55	0,6	0,66
600	0,06	0,12	0,18	0,24	0,3	0,36	0,42	0,48	0,54	0,6	0,66	0,72
650	0,06	0,13	0,19	0,26	0,32	0,39	0,45	0,52	0,58	0,65	0,71	0,78
700	0,07	0,14	0,21	0,28	0,35	0,42	0,49	0,56	0,63	0,7	0,77	0,84
750	0,07	0,15	0,22	0,3	0,37	0,45	0,52	0,6	0,67	0,75	0,82	0,9
800	0,08	0,16	0,24	0,32	0,4	0,48	0,56	0,64	0,72	0,8	0,88	0,96
850	0,08	0,17	0,25	0,34	0,42	0,51	0,59	0,68	0,76	0,85	0,93	1,02
900	0,09	0,18	0,27	0,36	0,45	0,54	0,63	0,72	0,81	0,9	0,99	1,08
950	0,09	0,19	0,28	0,38	0,47	0,57	0,66	0,76	0,85	0,95	1,04	1,14
1000	0,1	0,2	0,3	0,4	0,5	0,6	0,7	0,80	0,9	1	1,1	1,2

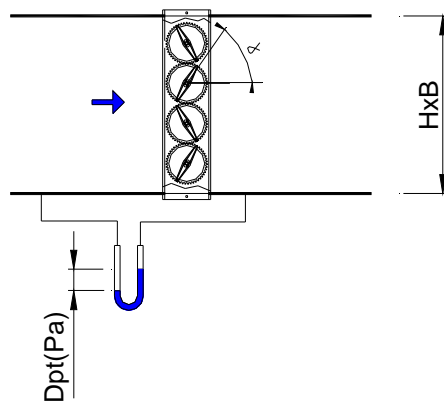

SQR SERIES

VITESSE DE LA SECTION, PERTE DE CHARGE, PUISSANCE SONORE

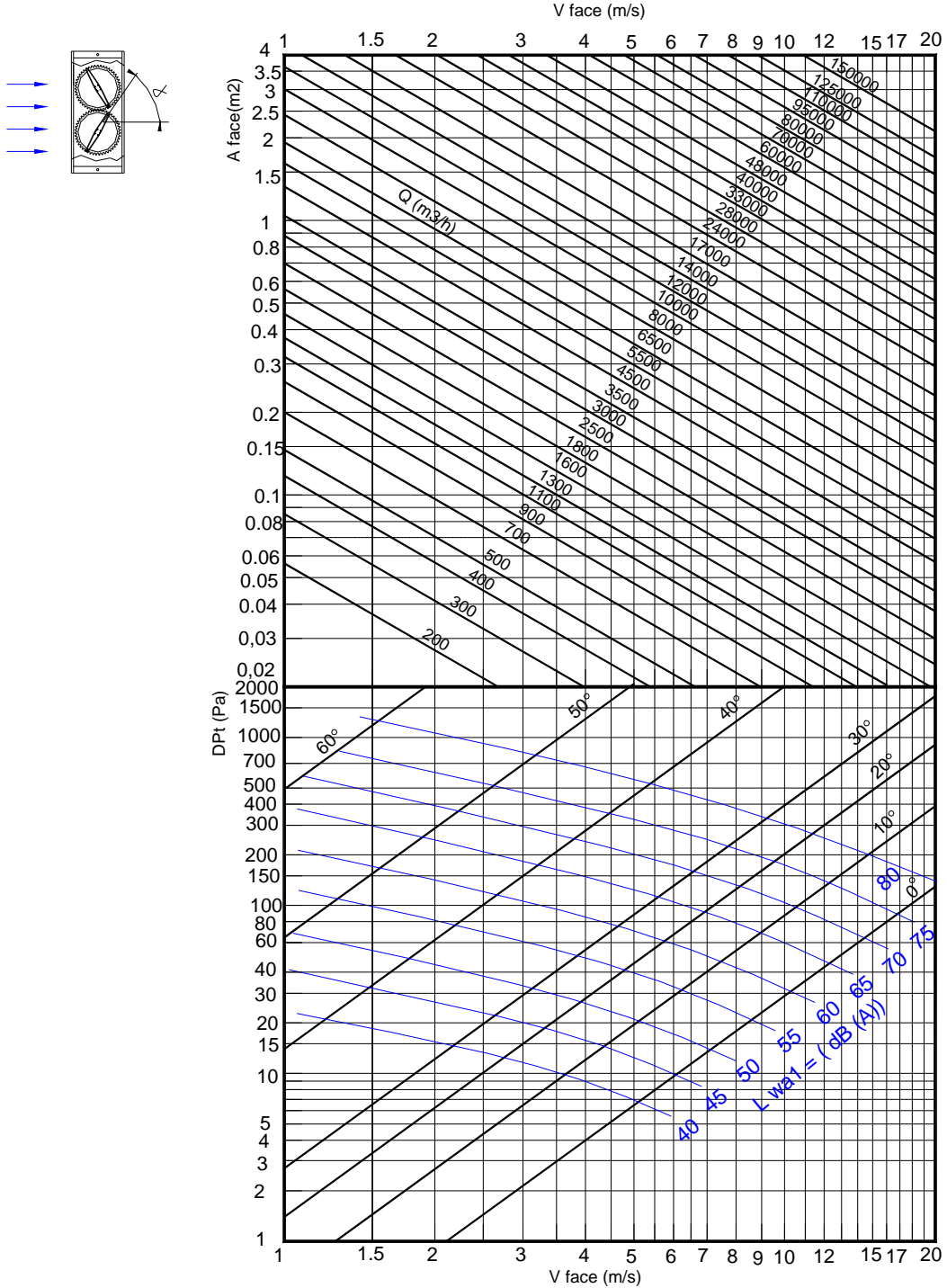

SQR SERIES

COUPLE

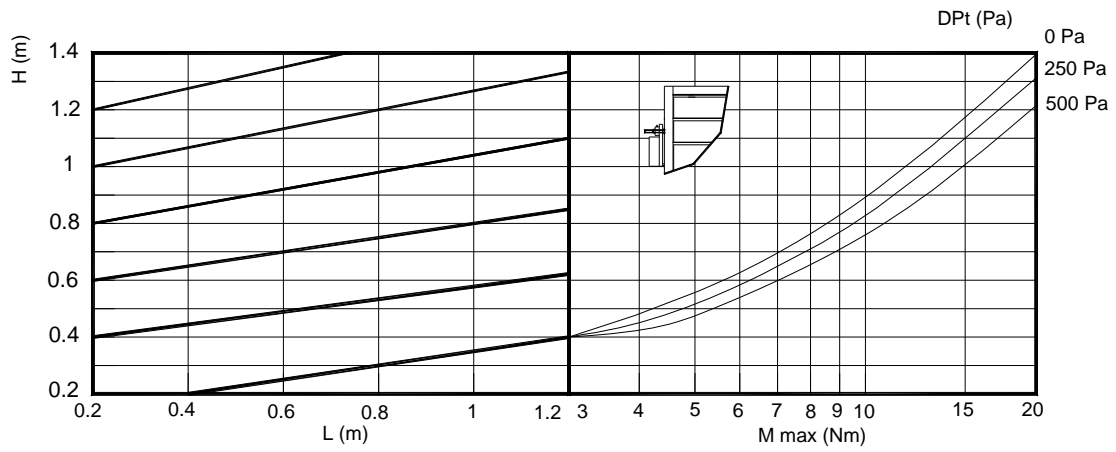

SQR-EH

FUITE

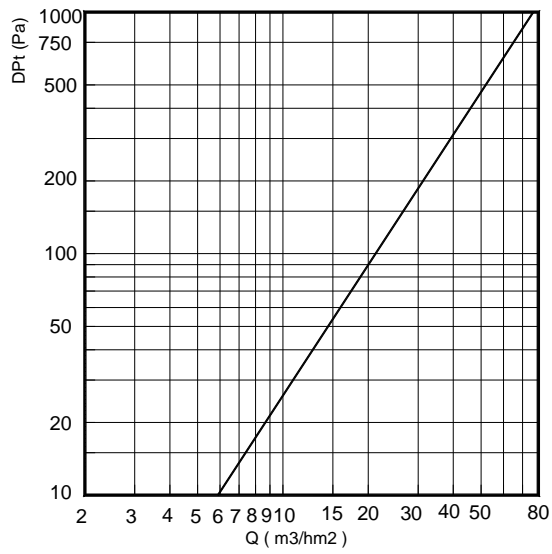

SIEMENS Wiring diagrams

ON/OFF – 3P CONTROL.

GDB / GLB 14..1E

Open-close, Single wire control

AC 24 V 
DC 24 V ... 48 V ...

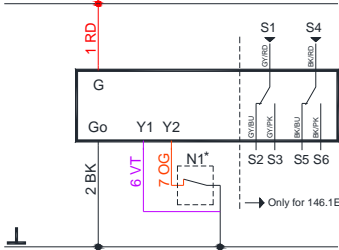

GDB / GLB 14..1E

Open-close, Two wire control

AC 24 V 
DC 24 V ... 48 V ...

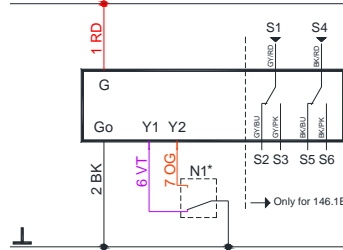

GDB / GLB 14..1E

GEB 13..1E

Three-position control

AC 24 V 
DC 24 V ... 48 V ...

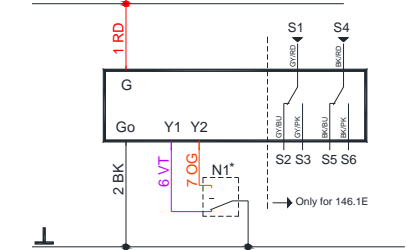

GDB / GLB 34..1E

Open-close, Single wire control

AC 100 ... 240 V 

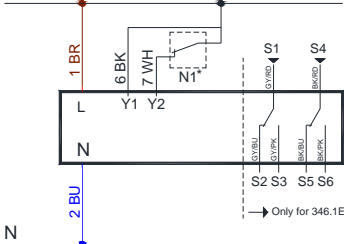

GDB / GLB 34..1E

Open-close, Two wire control

AC 100 ... 240 V 

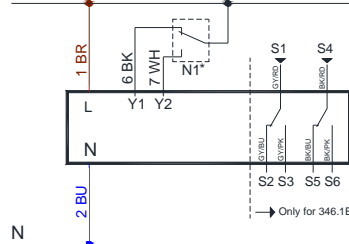

GDB / GLB 34..1E

GEB 33..1E

Three-position control

AC 100 ... 240 V 

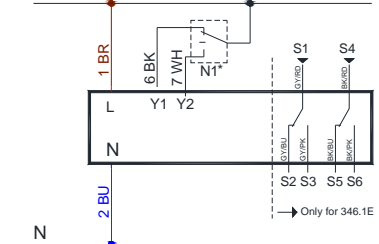

SPRING RETURN - ON/OFF – Two-position control

GMA 121.1E

Two-position control

AC 24 V 
DC 24 V ... 48 V ...

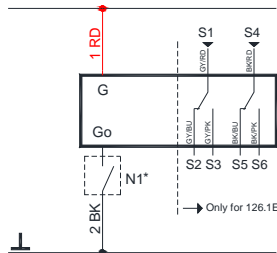

GMA 321.1E

Two-position control

AC 100 ... 240 V 

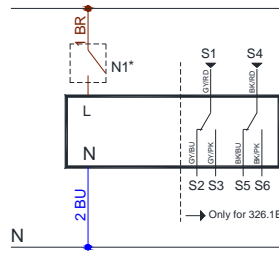

N1*. Accessory control. See wiring diagrams accessories.

Wiring	Code	N°	Color	Description	
Actuators AC 24 V~ DC 24..48V	G	1	RD Red	System potential 24 AC/DC	
	G0	2	BK Black	System Neutral	
	Y1	6	VT Purple	Positioning AC/DC 0V. cw	
	Y2	7	OG Orange	Positioning AC/DC 0V. ccw	
	Y	8	GY Grey	Signal in (0-10V)	
	U	9	PK Pink	Signal out (0-10 V)	
	Actuators AC 230 V~	L	3	BR Brown	Line 100 .. 240 AC
		N	4	BU Blue	Neutral conductor
		Y1	6	BK Black	Positioning AC 230V. cw
Y2		7	WH White	Positioning AC 230V. ccw	
G+		1	RD Red	Potential aux. 24 AC/DC	
G-		2	BK Black	Neutral aux. 24 AC/DC	
Y		8	GY Grey	Signal in (0-10V)	
U	9	PK Pink	Signal out (0-10 V)		
Auxiliary contacts	Q11	S1	GY/RD	Input switch A	
	Q12	S2	GY/BU	Contact NC switch A	
	Q14	S3	GY/PK	Contact NO switch A	
	Q21	S4	BK/RD	Input switch B	
	Q22	S5	BK/BU	Contact NC switch B	
	Q24	S6	BK/PK	Contact NO switch B	

MODULATING control 0-10 V

GDB / GLB / GEB 16..1E

Modulating control

AC 24 V 
DC 24 V ... 48 V ...

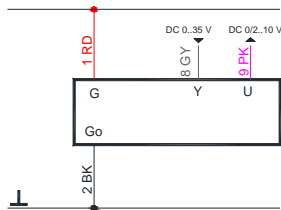

GDB / GLB 36..1E

Modulating control

AC 100 ... 240 V 

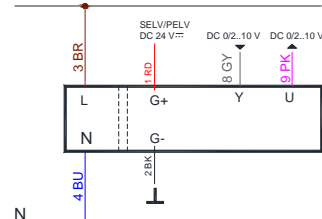

This information is provided by way of indication.
Consult the manufacturer catalogue for all updated
documentation.

<https://www.buildingtechnologies.siemens.com/bt/global/en/products/HVAC-Products/Damper-actuators/Actuators-for-HVAC-applications/Pages/Actuators-for-HVAC-applications-default.aspx>

BELIMO Wiring diagrams

ON/OFF – 3P CONTROL.

LM-24A..(S)
NM-24A..(S)
AC/DC 24 V, Open-close

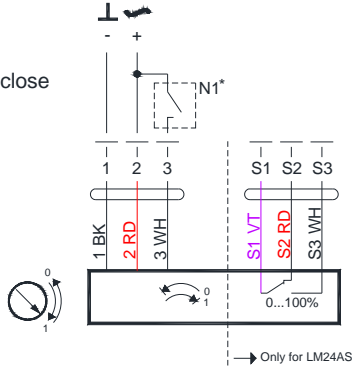

LM-24A..(S)
NM-24A..(S)
AC/DC 24 V, 3-point

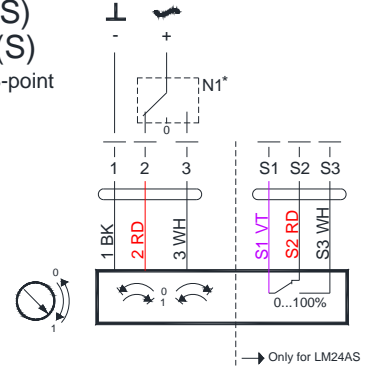

LM-230A..(S)
NM-230A..(S)
AC 230 V, Open-close

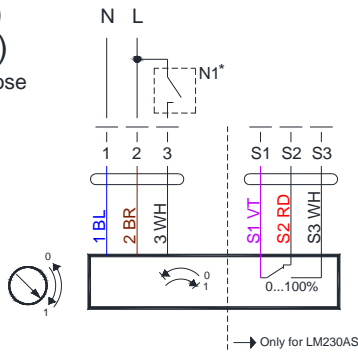

LM-230A..(S)
NM-230A..(S)
AC 230V, 3-point

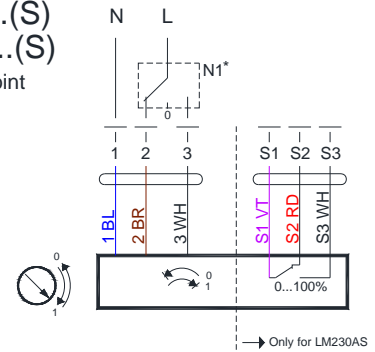

SPRING RETURN - ON/OFF – Two-position control

LM-230A..(S)
NM-230A..(S)
AC 230 V, Open-close

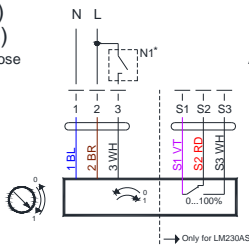

LM-230A..(S)
NM-230A..(S)
AC 230V, 3-point

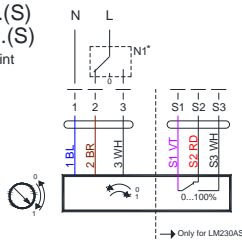

N1*. Accessory control. See wiring diagrams accessories.

Wiring	Code	N°	Color	Description
Actuators Open-close AC 24 V~ DC 24..48V	-	1	BK Black	System Neutral
	+	2	RD Red	System potential 24 AC/DC
		3	WH White	Positioning AC/DC 0V.
Actuators modulating AC-DC 24 V AC 230V	-	1	BK Black	System Neutral
	+	2	RD Red	System potential 24 AC/DC
		3	WH White	Signal in (0) 2-10V
		5	OG Orange	Signal out 2-10V
Actuators AC 230 V~	L	1	BU Blue	Line 100 .. 240 AC
	N	2	BR Brown	Neutral conductor
	G+	1	BK Black	Neutral aux. 24 AC/DC
	G-	2	RD Red	SG..24
	U	3	WH White	Signal in (0-10V)
	5	OG Orange	Signal out (0-10 V)	
Auxiliary contacts	S1	S1	VT Violet	Input switch A
	S2	S2	RD Red	Contact NC switch A
	S3	S3	WH White	Contact NO switch A

MODULATING control 0-10 V

LM24A-SR
NM24A-SR
AC/DC 24 V, Modulating

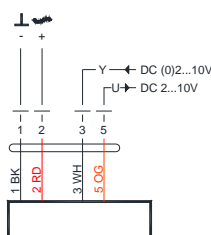

LM230A-SR
NM230A-SR
AC 230 V, Modulating

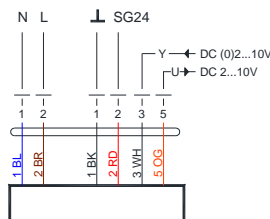

This information is provided by way of indication.
Consult the manufacturer catalogue for all updated
documentation.

<http://www.belimo.ch/CH/EN/PDF/index.cfm>

TF Wiring diagrams

TF + SIEMENS actuators

AC/DC 24 V - ON/ OFF control

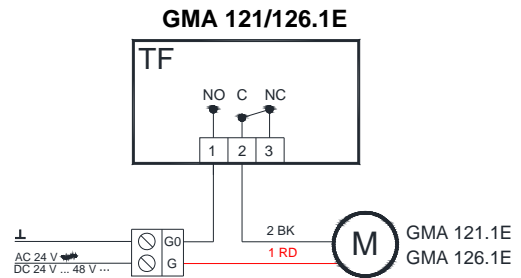
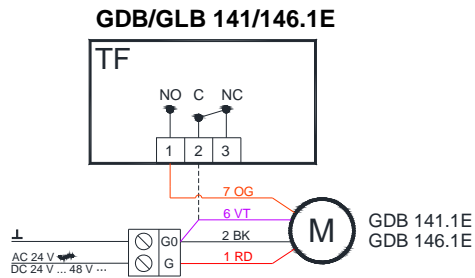

AC 230 V - ON/ OFF control

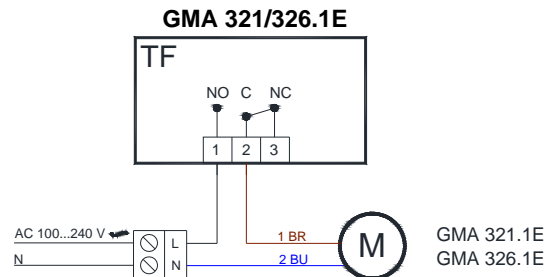
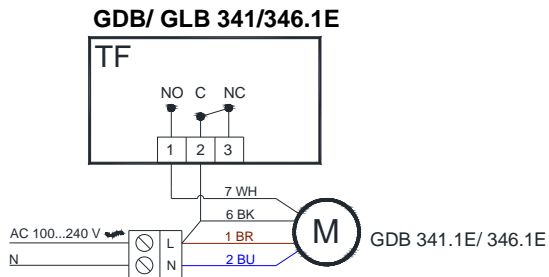

TF + BELIMO actuators

AC/DC 24 V - ON/ OFF control

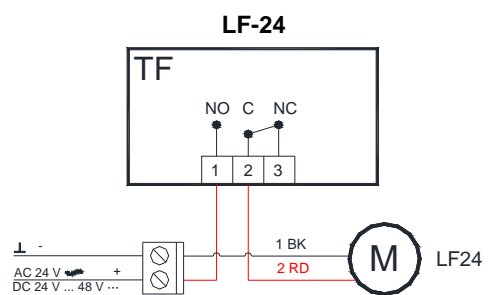
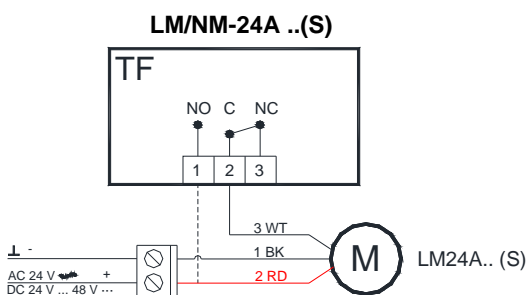

AC 230 V - ON/ OFF control

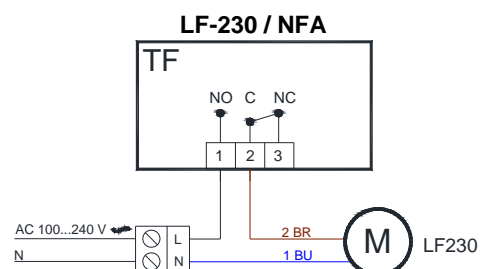
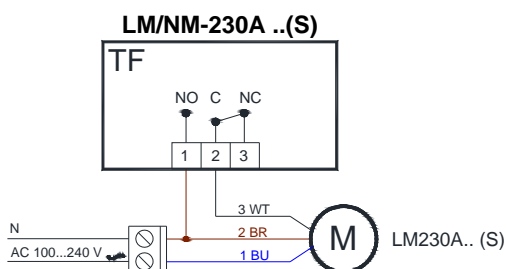

RDG400 Wiring diagrams

RDG 400 + SIEMENS actuators

Modulating control + manual changeover

GDB/GLB 161.1E

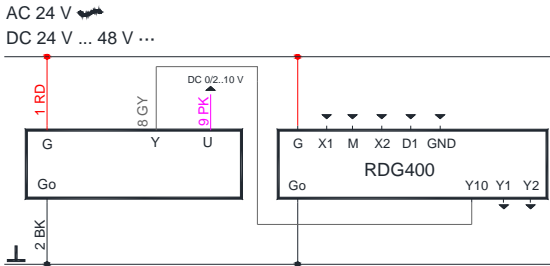

GDB/ GLB 361.1E

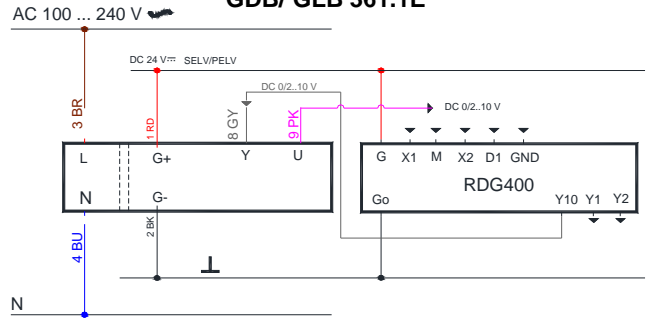

RDG 400 + BELIMO actuators

Modulating control + manual changeover

LM/ NM-24A -SR

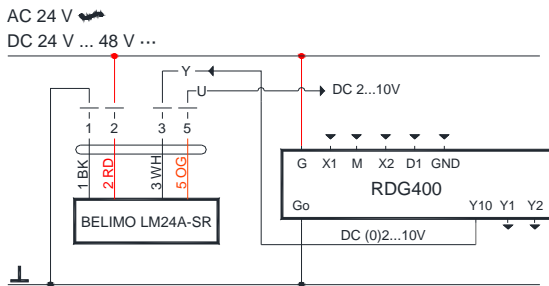

LM/NM230A-SR

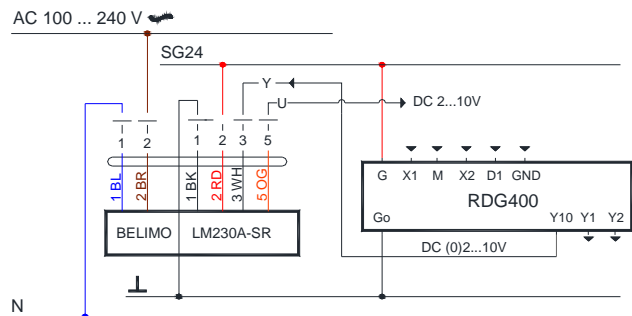

CO2-WR Wiring diagrams

CO2-WR+ SIEMENS GDB/GLB 141.1E

On/OFF control

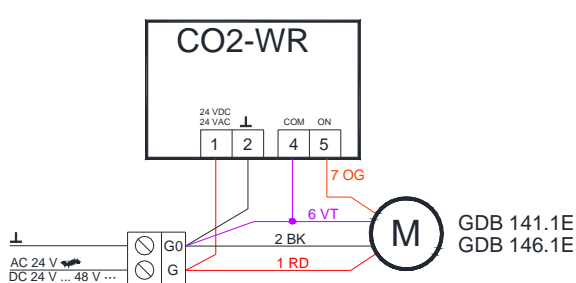

CO2-WR+ BELIMO LM/NM24A.. (S)

On/OFF control

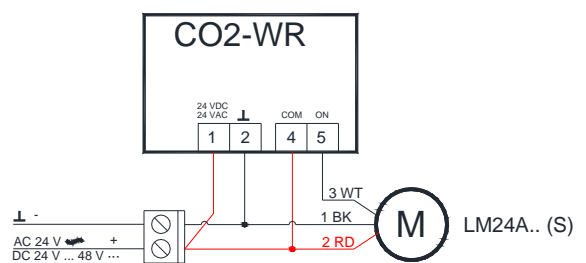

	J4	J5	Relay
800 ppm	disconnected	disconnected	CO2 > 900 ppm. Relay ON; CO2 < 700 ppm Relay OFF
1000 ppm	connected	disconnected	CO2 > 1100 ppm. Relay ON; CO2 < 900 ppm Relay OFF
1200 ppm (default)	disconnected	connected	CO2 > 1200 ppm. Relay ON; CO2 < 1100 ppm Relay OFF
1400 ppm	connected	connected	CO2 > 1500 ppm. Relay ON; CO2 < 1300 ppm Relay OFF

CO2-WP Wiring diagrams

CO2-WP + SIEMENS actuators

AC/DC 24 V – Modulating control GDB/GLB 161.1E

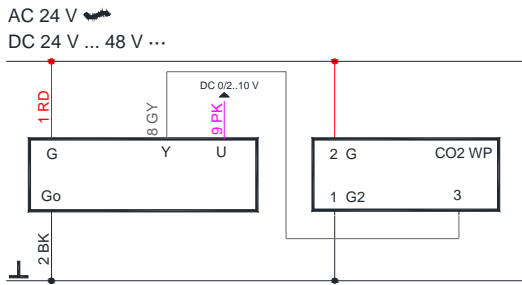

AC 230 V – Modulating control GDB/GLB 361.1E

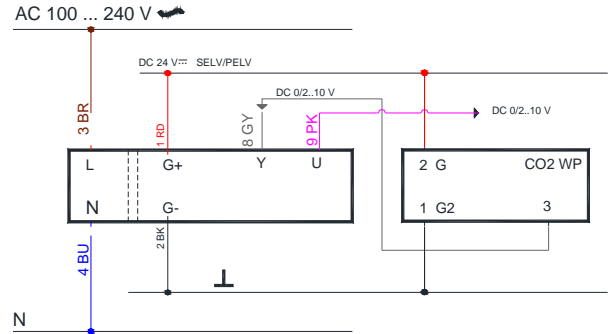

CO2-WP + BELIMO actuators

AC/DC 24 V – Modulating control LM/NM 24A-SR

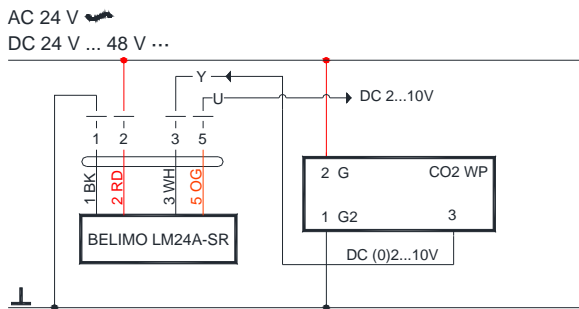

AC 230 V – Modulating control

LM/ NM 230A - SR

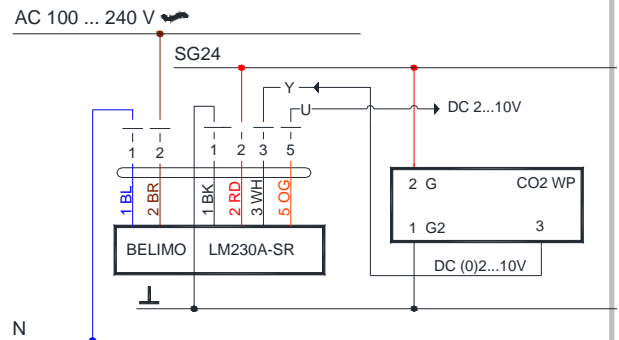

CO2-WP Setting

J3 J1 J2 S1 S2

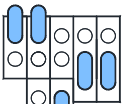

J4 J5

	J1	J2
0-10 VDC (default)	disconnected	disconnected
2-10 VDC	connected	disconnected

	J3
PID out put (default)	disconnected
Linear output	connected

	J4	J5
350 ppm	disconnected	disconnected
500 ppm	connected	disconnected
800 ppm (default)	disconnected	connected
1200 ppm	connected	connected

CO2-D Wiring diagrams

CO2-WD + SIEMENS actuators

**AC/DC 24 V – Modulating control
GDB/GLB 161.1E**

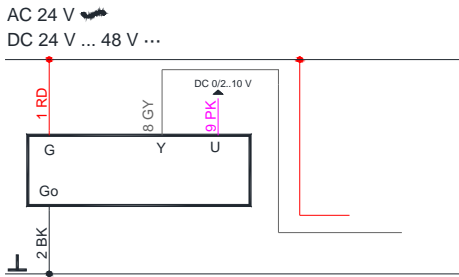

**AC 230 V – Modulating control
GDB/GLB 361.1E**

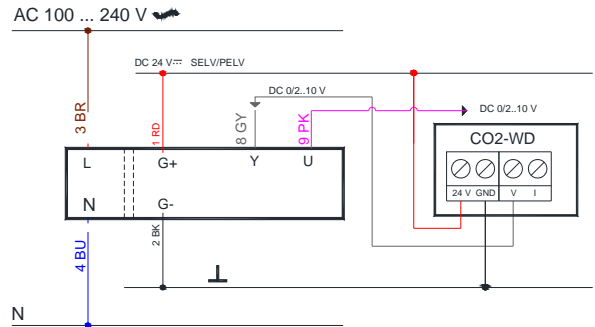

CO2-WD + BELIMO actuators

**AC/DC 24 V – Modulating control
LM/NM24A-SR**

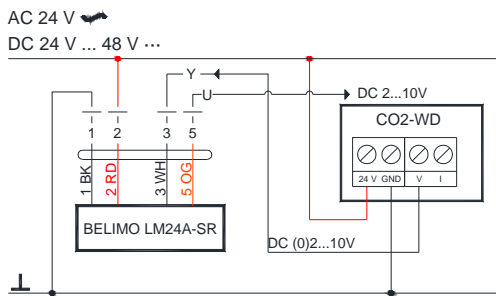

**AC 230 V – Modulating control
LM/NM230A - SR**

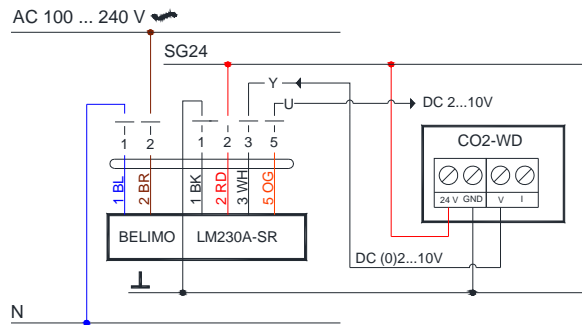

OS-360 Wiring diagrams

OS360+ SIEMENS GDB/GLB 141.1E

On/OFF control

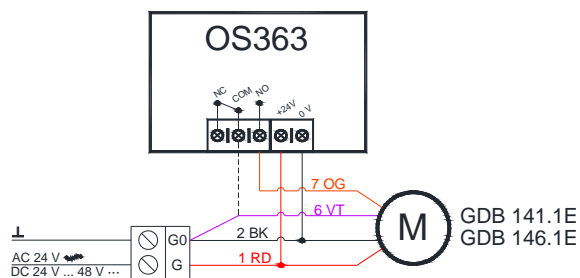

DELAY SETTING



OS360+BELIMO LM/NM 24A.. (S)

On/OFF control

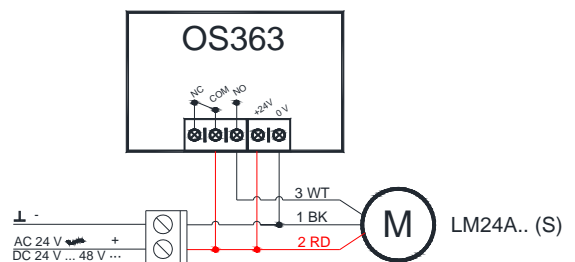

	A	B	C	D	E	F
ON	0 sec	10 sec	30 sec	1 min	5 min	10 min
OFF	10 sec	1 min	5 min	10 min	20 min	30 min