

FOC-EIS-180 Fire dampers CE

“ The fire dampers **FOC-EIS-180** work as a separator between two sectors of fire and ensure the same fire resistance that the structural elements of compartmentalisation, which limits the risk of spreading of fire by interior of the building.

“ FOC-EIS-180 fire dampers are according with the following standards:

European Test Standard, EN 1366-2

*(Fire resistance tests for service installations .
Part 2: Fire dampers)*

European Classification Standard, EN 13501-3

(Fire classification of construction products and building elements .

*Part 3: Classification using data from fire resistance tests on products and elements used in building service installations:
fire resisting ducts and fire dampers,*

European Standard for CE Marking, EN 15650

(Ventilation for buildings. Fire dampers)

European Test Standard, EN 60529:1991

(Degrees of protection provided by enclosures (IP Code))

European Test Standard EN 1751

*(Ventilation for buildings . Air terminal devices .
Aerodynamic testing of dampers and valves)*

International Test Standard ISO 10294-4

*(Fire resistance tests . Fire dampers for air distribution systems
Part 4: Test of thermal release mechanism)*

“ The casing is made of galvanized steel, and joined by welding.

“ The housing is made from galvanized steel. It has a symmetrical design that allows wall mounting regardless of air flow.

“ The blade is made of ceramic material resistant to high temperatures and abrasion.

“ These dampers meet the conditions required for the symbol (S) to cold smoke seal.

“ The airtightness to the passage of cold smoke is achieved through a joint between the perimeter of the housing and the blade.

“ For high temperatures, the damper is equipped with an expanding intumescent seal, forming a paste that prevents the passage of hot air and smoke from one side of the damper to another.

“ A rubber sealing ring at both ends of the casing ensures an airtightness between the damper and the ducts.

“ The operating devices of the dampers is automatic shooting by means of a thermal fuse calibrated at 72 °C to activate the closure when reaches that temperature. Reset is manual except for motorized dampers.

DECLARATION OF PERFORMANCES

DECLARATION OF PERFORMANCE (N° 0370-CPR-1392)					V01/19
1. Product and identification name:					Fire damper %6OC-EIS-180+
2. Name and address of manufacturer:					Madel Air Technical Diffusion S.A, C/ Pont de les Bruixes P-5, P.I. La Gavarra, 08540 CENTELLES (Barcelona)
3. Uses to:					To prevent fire and reduce smoke spreading from one fire compartment to another through the air ductwork system which may penetrate fire separating vertical compartments, according to Standard EN 15650:2010 (annex ZA.1).
4. Assessment of conformity system:					System 1, according to Construction Products Regulation nº 305/2011
5. Certification body:					APPLUS - 0370 Performed tasks: - Determination of the product type on the basis of type testing (including sampling), type calculation, tabulated values or descriptive documentation of the product; - Initial inspection of the manufacturing plant and of factory production control; - Continuous surveillance, assessment and evaluation of factory production control. System 1 Certification number: 0370 . CPR . 1392 Test report: 7286/06, 18/12815-1709, 10/101611-1329, 18/12815-2189, 18/17552-1211, 10/1016611-2699
6. Performances (EN 15650 :2010):					
Essential characteristics					Performances
Dimensions	Type	Wall	Type of installation	Mechanism orientation	Class
Ø200 - 630 mm	Rigid wall	Reinforced concrete wall - 150 mm	Built-in	0-180°	EI 180 (v ₆ i o) S (300Pa)
	Rigid wall	Brick wall - 150 mm	Built-in	0-180°	EI 180 (v ₆ i o) S (300Pa)
	Rigid floor	Reinforced concrete floor - 200 mm	Built-in	0-180°	EI 180 (v ₆ i o) S (500Pa)
Nominal activation conditions/ sensitivity:					
Sensing element load bearing capacity					Approved
Sensing element response temperature					
Response delay according to EN 1366-2:					
Closure time					Approved
Operational reliability according to EN 1366-2					
Cycling (opening and closing) on fire test.					50 cycles
Cycling (opening and closing) according to Standard for CE Marking					δ - /MA/ - 300 cycles, δ - /MAF/ - 300 cycles, δ̄ - /MFSδ̄ V/ - 10.200 cycles, δ̄ - /MFBδ̄ V/ - 10.200 cycles
Durability of response delay according to EN1366-2:					
Sensing element response temperature and load bearing capacity					Approved
Durability of operational reliability according to 15650:					
Opening and Closing cycle					Approved
7. The performances of the product identified in point 1, are in line with the declared performance in point 6. This declaration of performance is issued under the responsibility of the manufacturer listed in point 2. Signed for and on behalf of the manufacturer:					
					
Joan Arcarons Alibés (Technical Director)		Centelles, 10/01/19			

CLASSIFICATION

FOC-EIS-180 Circular damper with direct connection to the ducts.

Å -MA Manual resetting damper. Is not necessary to open the box device.

Å -MFÅ Damper operated by an actuator with switch off device at 24 or 230V.

PARTS

FOC-EIS-180-MA

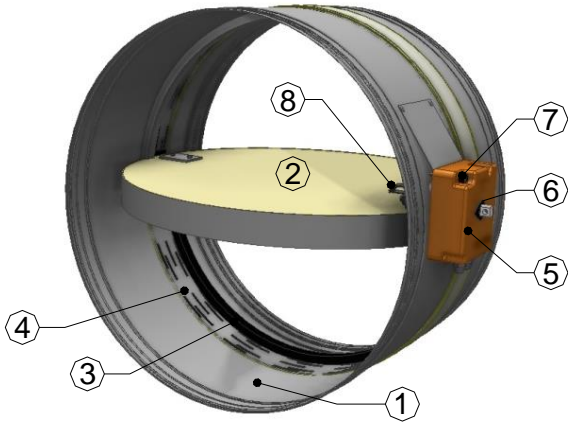

- 1. Casing
- 2. Blade
- 3. Airtightness seal
- 4. Cold bridging
- 5. Manual device /MA/
- 6. Position indicator
- 7. Test button
- 8. Thermal fuse 72°C

FOC-EIS-180-MFÅ

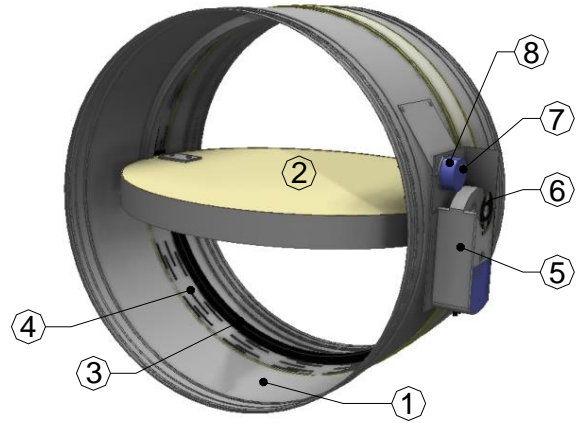

- 1. Casing
- 2. Blade
- 3. Airtightness seal
- 4. Cold bridging
- 5. Actuator /MFö V/
- 6. Position indicator
- 7. Test switch
- 8. Thermoelectrical fuse 72°C

DIMENSIONS

FOC-EIS-180-MA

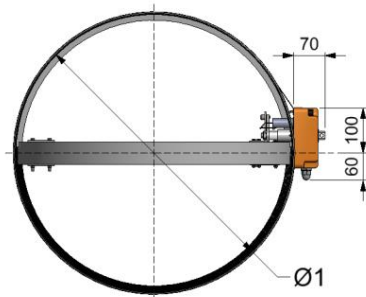
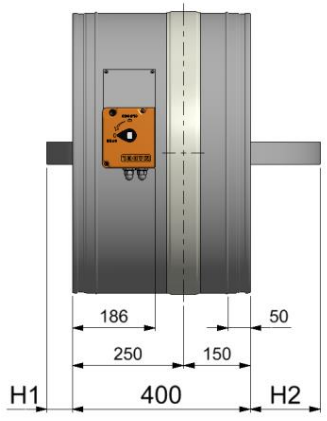

Dn	Ø1 (mm)	H1 (mm)	H2 (mm)
355	353	-	25
400	398	-	50
500	498	-	100
630	628	60	160

FOC-EIS-180-MFÅ

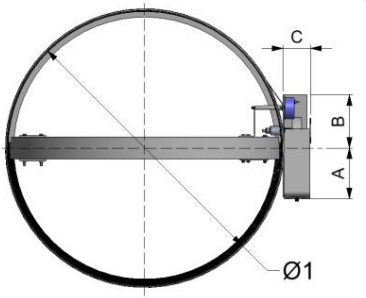
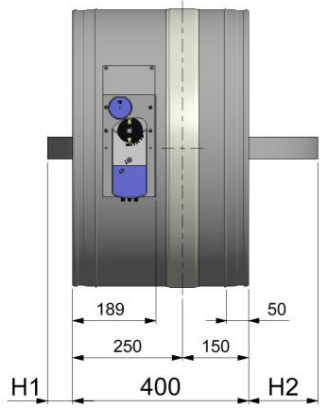

Dn	Ø1 (mm)	H1 (mm)	H2 (mm)
355	353	-	25
400	398	-	50
500	498	-	100
630	628	60	160

Ref.	A (mm)	B (mm)	C (mm)
MFS...	155	81	64
MFB...	190	81	57

OPERATING DEVICES

Å -/MA/ Manual resetting damper. Automatic shooting by means of a thermal fuse calibrated at 72 °C.

Standard:

- Thermal fuse 72°C
- Manual test button
- Manual resetting
- Position indicator
- IP42 protection

Optional

Å -/PIF/ Closed switches device

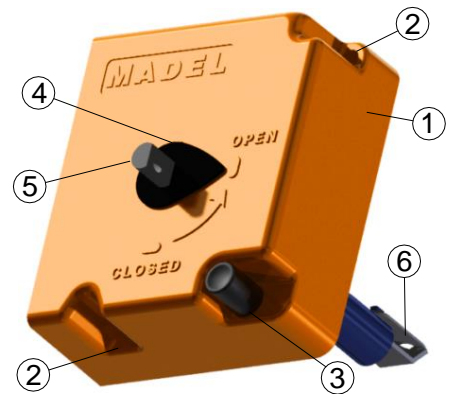
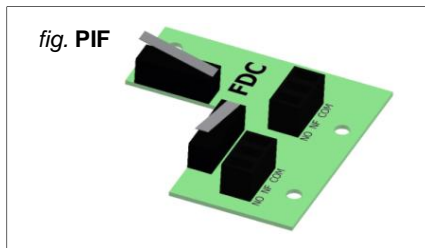
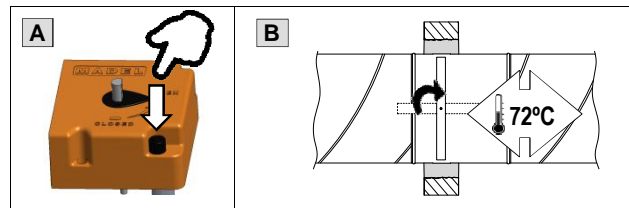

fig. MA

1. Plastic command cover
2. Screws for cover attachment
3. Manual test button
4. Position indicator
5. Manual resetting axle.
6. Thermal fuse 72°C

Close (unlocking)

- ~ **Manual:** Pressing the unlocking button (A)
- ~ **Automatic:** The fusible link reaches 72°C (B)
- ~ **Remote:** -



Open (resetting)

- ~ **Manual:** Turning counterclockwise 90° the manual resetting axle using a tool with a smaller diameter than 8mm (C)
- ~ **Automatic:** -

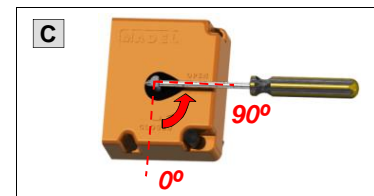

Electrical connection

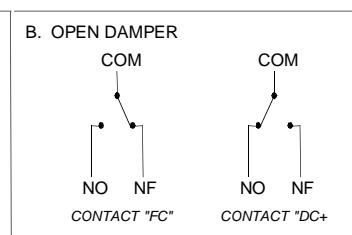
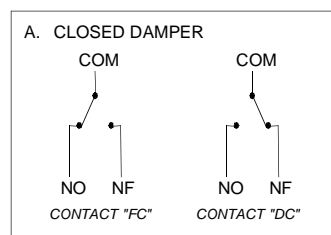
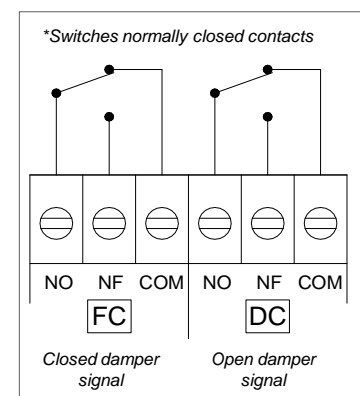
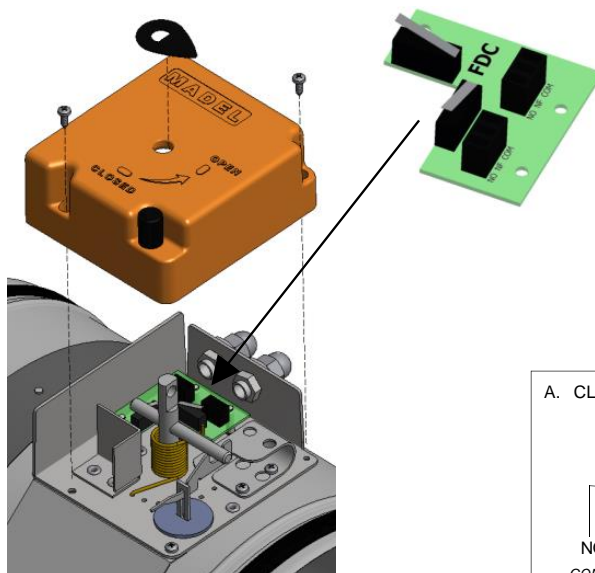

OPERATING DEVICES

Å - /MFSÅ / Damper operated by remote control by means of an actuator with switch off device at 24 or 230V or a thermal fuse calibrated at 72 °C. .

Standard:

- Internal and external thermoelectrical fuse 72°C
- Automatic resetting
- Automatic closing by fuse 72°C
- Remote closing by interruption of power supply
- Manual test switch
- LED status fusible indicator
- Position damper indicator
- Closed switches
- IP54 Protection

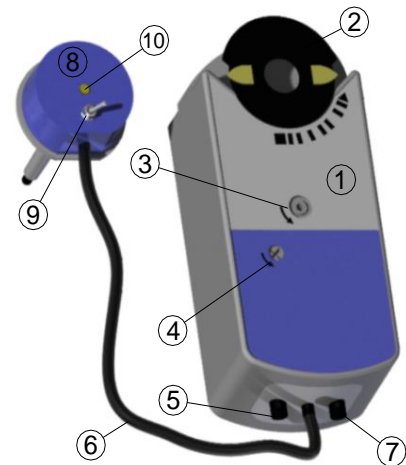

fig. MFSÅ V

1. Actuator
2. Position damper indicator
3. Manual resetting
4. Manual lock
5. Plug closed switches cable
6. Thermoelectrical fuse cable
7. Power supply cable
8. Thermoelectrical fuse 72°C
9. Manual test switch
10. LED status fusible indicator

Reference a/size	Torque	Voltage	Consumption	Time Open/ Close
MFS24V	4 Nm	CA 24V CC 24/48V	3,5W (running)/ 2W (stationary)	90s/ 15s
MFS230V	4 Nm	CA 230V	4,5W (running)/ 3,5W (stationary)	90s/ 15s
MFS24V	7 Nm	CA 24V CC 24/48V	3,5W (running)/ 2W (stationary)	90s/ 15s
MFS230V	7 Nm	CA 230V	4,5W (running)/ 3,5W (stationary)	90s/ 15s

Ref.	∅ _{nominal}
MFSÅ	< 500
MFSÅ	≥ 500

Close (unlocking)

- ~ **Manual:** Pressing the manual test switch (A)
- ~ **Remote:** By interrupting the power supply (B)
- ~ **Automatic:** The fusible link reaches 72°C (C)

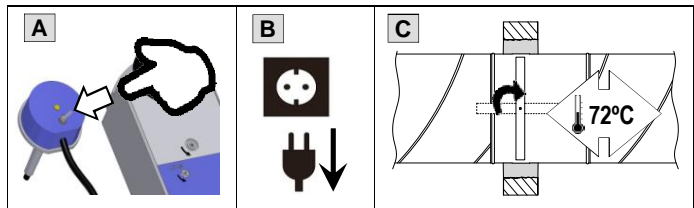

Open (resetting)

- ~ **Manual:** Turning counterclockwise the manual resetting with allen key (D)
To keep the blade open, lock by manual lock
- ~ **Automatic:** By supplying the power supply (E)

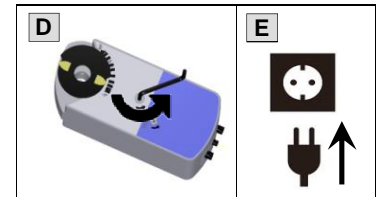

Electrical connection

AUXILIARY SWITCHES CABLE			
MEANING	Nº	COLOR	
Switch "A" input	S1	grey/ red	
Switch "A" normally-closed contact	S2	grey/ blue	
Switch "A" normally-open contact	S3	grey/ pink	
Switch "B" input	S4	black/ red	
Switch "B" normally-closed contact	S5	black/ blue	
Switch "B" normally-open contact	S6	black/ pink	

ACTUATOR 230VCA			
MEANING	Nº	COLOR	
Line 230VCA	3	Brown	
Neutral	4	Blue	

ACTUATOR 24VCA/24Å 48VCC			
MEANING	Nº	COLOR	
System potential 24VCA/ 24Å 48VCC	1	red	
System neutral	2	black	

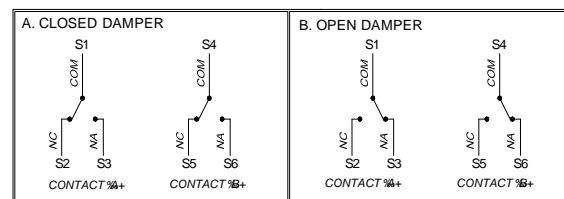

~ Fixed switching points at 5° and 80°

~ Fixed switching point at 5° to contact %A+

~ Fixed switching point at 80° to contact %B+

OPERATING DEVICES

Å - /MFBÅ / Damper operated by remote control by means of an actuator with switch off device at 24 or 230V or a thermal fuse calibrated at 72 °C. .

Standard:

- Internal and external thermoelectrical fuse 72°C
- Automatic resetting
- Automatic closing by fuse 72°C
- Remote closing by interruption of power supply
- Manual test switch
- LED status fusible indicator
- Position damper indicator
- Closed switches
- IP54 Protection

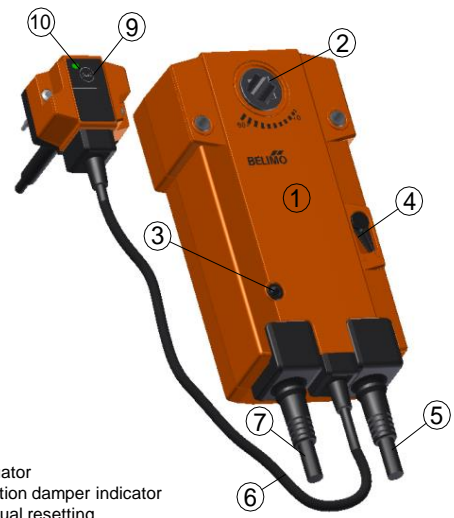

1. Actuator
2. Position damper indicator
3. Manual resetting
4. Manual lock
5. Plug closed switches cable
6. Thermoelectrical fuse cable
7. Power supply cable
8. Thermoelectrical fuse 72°C
9. Manual test button
10. LED status fusible indicator

fig. MFBÅ V

Reference a/size	Torque	Voltage	Consumption	Time Open/ Close
MFB24V	9 Nm	CA 24V/ CC 24/48V	4W (running)/ 1,4W (stationary)	60s/ 20s
MFB230V	9 Nm	CA 230V	4,5W (running)/ 3,5W (stationary)	60s/ 20s

Close (unlocking)

- ~ **Manual:** Pressing the manual test switch (A)
- ~ **Remote:** By interrupting the power supply (B)
- ~ **Automatic:** The fusible link reaches 72°C (C)

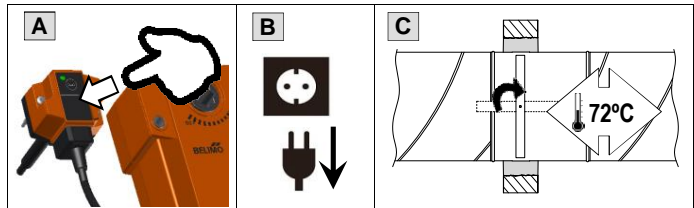

Open (resetting)

- ~ **Manual:** Turning counterclockwise the manual resetting with allen key (D)
To keep the blade open, lock by manual lock
- ~ **Automatic:** By supplying the power supply (E)

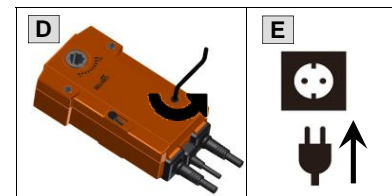

Electrical connection

MEANING	N°	BFL/BFN	BF
Switch "A" input	S1	Violet	White
Switch "A" normally-closed contact	S2	Red	White
Switch "A" normally-open contact	S3	White	White
Switch "B" input	S4	Orange	White
Switch "B" normally-closed contact	S5	Pink	White
Switch "B" normally-open contact	S6	Grey	White

ACTUATOR 24VCA/24Å 48VCC			
MEANING	N°	COLOR	
Neutral	1	Black	
System potential 24VCA/ 24Å 48VCC	2	Red	

ACTUATOR 230VCA			
MEANING	N°	COLOR	
Neutral	1	Blue	
Line 230VCA	2	Brown	

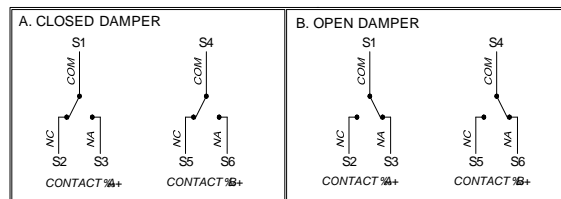

~ Fixed switching points at 5° and 80°

~ Fixed switching point at 5° to contact %A+

~ Fixed switching point at 80° to contact %B+

GENERAL POINTS

STORAGE AND HANDLING

- ~ Avoid to store outdoor.
- ~ Avoid the contact with liquids.
- ~ Avoid impacts.
- ~ Not to put loads on the blade.
- ~ Not to use the fire damper for a different purpose to which it's been designed.
- ~ Use the operating device for open/ close the damper, never through the blade.

SUPPORTING CONSTRUCTION AND INSTALLATION

- ~ The MADEL fire dampers are classified for the supporting constructions described in this manual or similar supporting constructions with a same or superior fire resistance (more thickness/ density or number of boards *(according to EN 1366-2)*).
- ~ Any variation in supporting construction as described in the previous point, different sealing or type of installation regarding this document, the fire damper will not comply the classification.
- ~ Install the fire damper with the blade closed and avoid excessive pressures in its casing.
- ~ Avoid to project materials to the interior of the tunnel.
- ~ Avoid vibrations in the installation.
- ~ Check the opening and closing after the installation.

MINIMAL DISTANCES *(a/ European Standard EN 1366-2)*

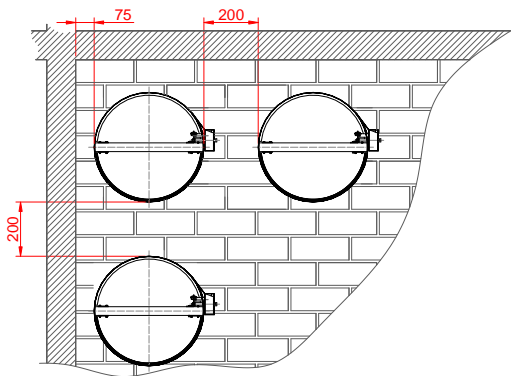

- ~ The minimum distance between fire dampers and construction elements will be 75mm.
- ~ The minimum distance between fire dampers will be 200mm.

INSTALLATION

- RIGID WALL

Dimensions	Supporting construction	Sealing	Classification
Ø200 to Ø630	Rigid wall	Brick wall ~ 150mm	EI180 (v_e i o) S (300Pa)

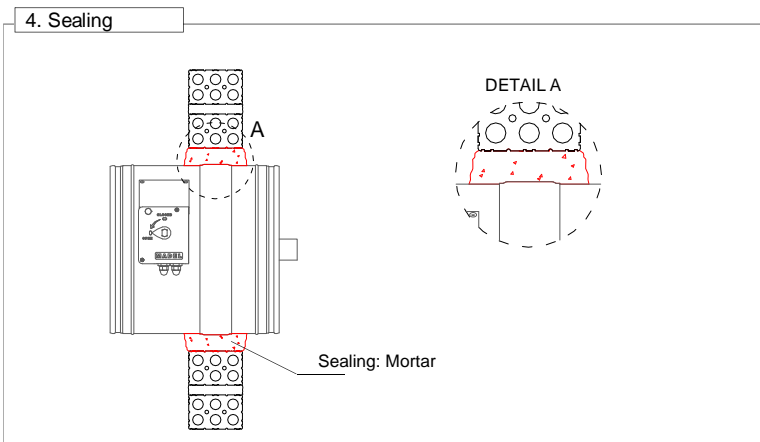
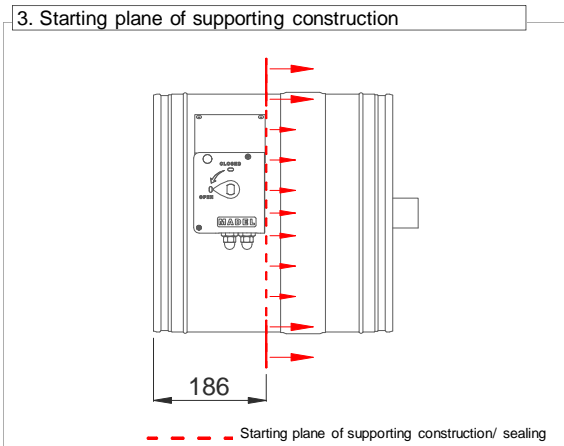
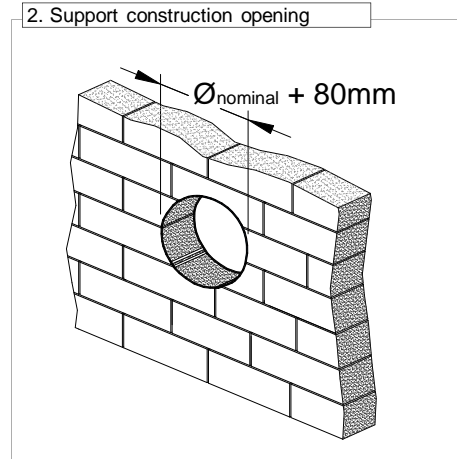
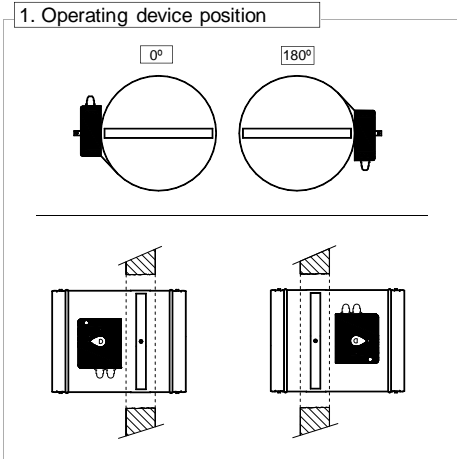

INSTALLATION

- RIGID FLOOR

Dimensions	Supporting construction		Sealing	Classification
Ø200 to Ø630	Rigid floor	Reinforced concrete ~ 200mm	Mortar	EI 180 (h _o i o) S (300Pa)

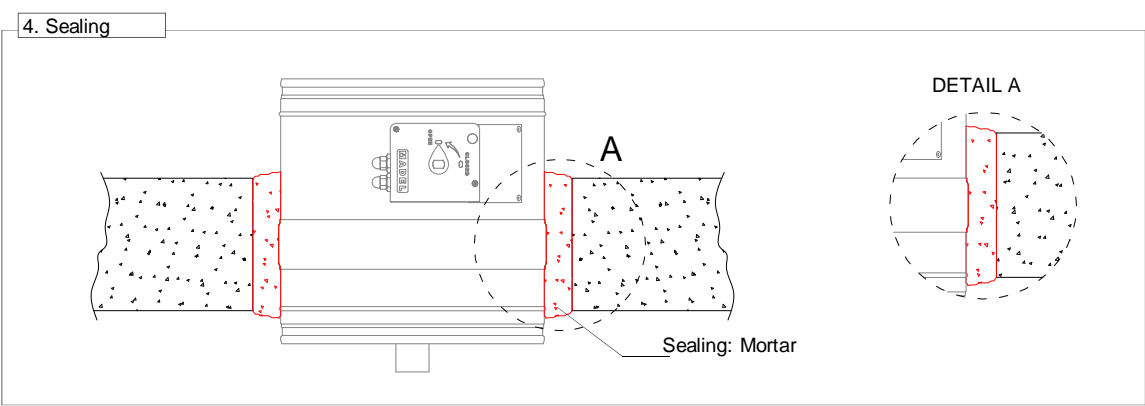
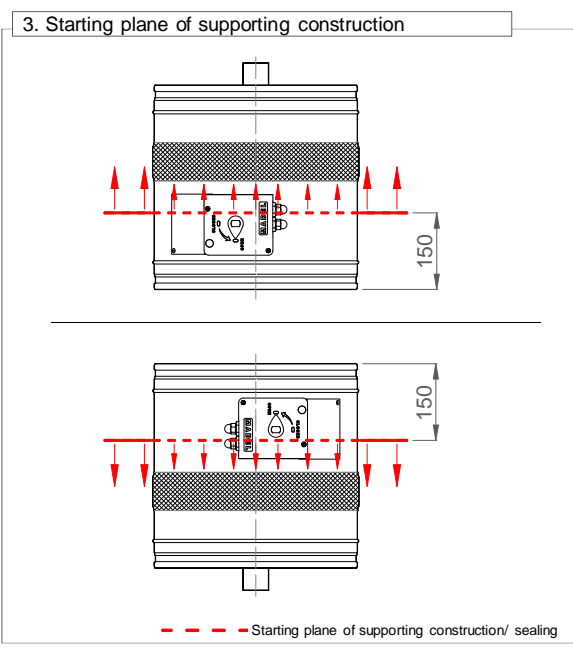
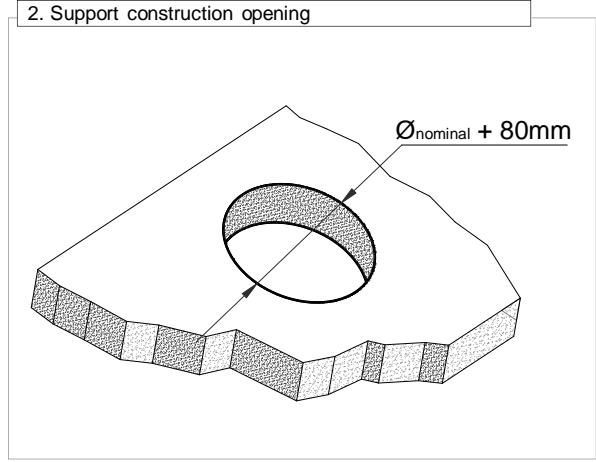
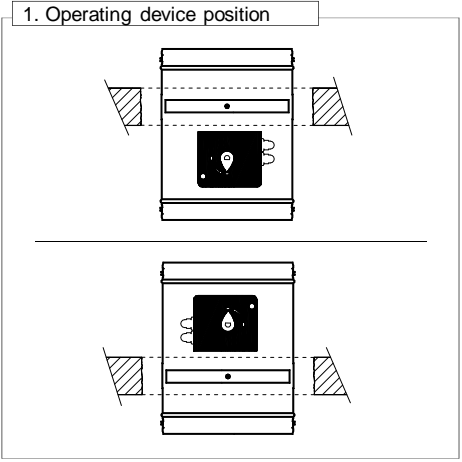

SPECIFICATION TEXT



(Manual)

Supply and mounting of circular fire damper classed EIS-180 in accordance to the European Standard *EN 13501-3* and certified CE according to *EN 15650*, series **FOC-EIS-180-MA diam. 500**.

Operated by means of a manual operating device. Built in galvanized steel and refractory material. Thermal fusible link at 72°C. An expanding joint together an air-tightness joint, as much prevent the propagation of smoke to high as to low temperature.

Manufacturer **MADEL**.

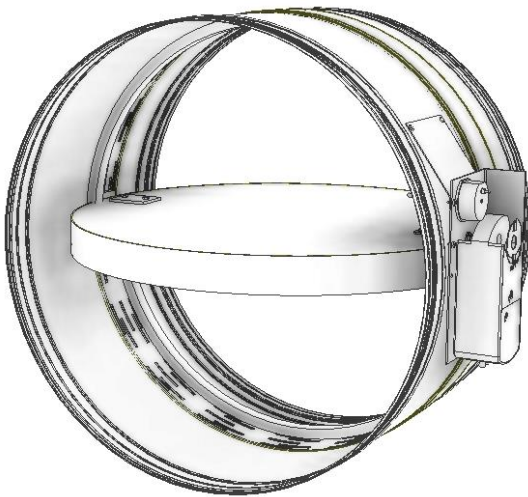

(Motorized)

Supply and mounting of circular fire damper classed EIS-180 in accordance to the European Standard *EN 13501-3* and certified CE according to *EN 15650*, series **FOC-EIS-180-MFS230V diam. 500**.

Operated by means of a motorized operating device. Built in galvanized steel and refractory material. Thermoelectric fusible at 72°C. An expanding joint together an air-tightness joint, as much prevent the propagation of smoke to high as to low temperature.

Manufacturer **MADEL**.

CODIFICATION

FOC-EIS-180 - MA - /PIF/ diamÅ Å

1

2

3

4

1. Product

4. Nominal diameter (mm)

2. Operating device

- **MA** (Manual)
- **MFS** (Siemens actuator)
- **MFB** (Belimo actuator)

3. Accessories

- **/PIF/** (Open-closed switches device)

TECHNICAL DATA

FOC-EIS-180

FREE AREA FOR THE AIR PASS

FOC	A k m ²	Qmin m ³ /h	Qmax m ³ /h
80	0.0005	54	126
100	0.0078	85	196
125	0.0122	130	307
160	0.020	216	504
200	0.031	330	780
250	0.049	529	1234
315	0.0779	840	1960
355	0.0989	1068	2492
400	0.125	1350	3150
500	0.196	2117	4940
630	0.312	3369	7862

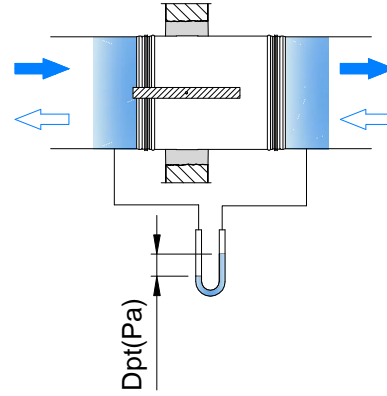

PRESSURE DROP AND SOUND POWER LEVEL

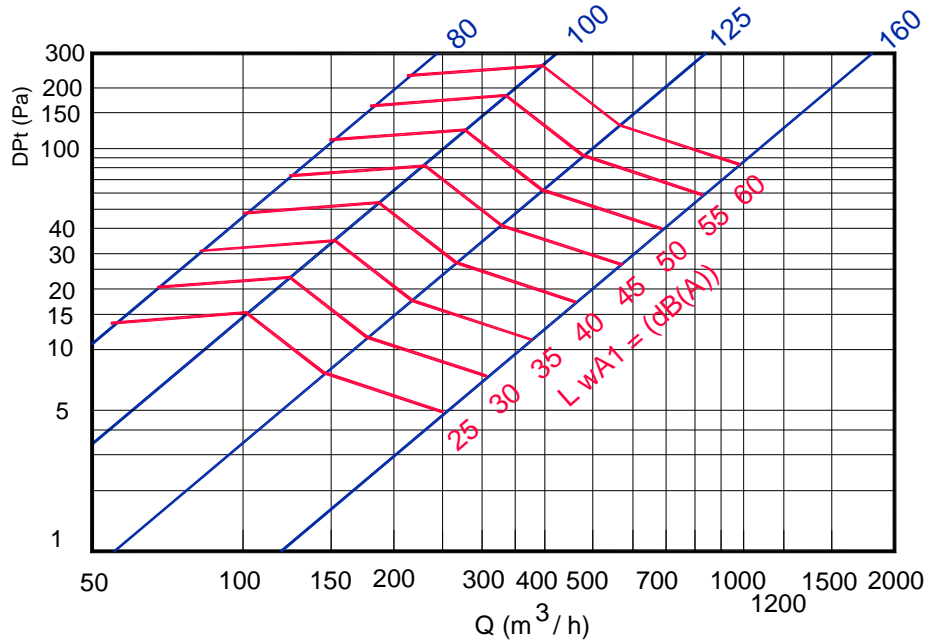

TECHNICAL DATA

FOC-EIS-180

PRESSURE DROP AND SOUND POWER LEVEL

