



Lievore,
Altherr
& Molina

KIS difusor lineal de microtoberas

**MADEL**[®]

El difusor lineal de la serie **KIS** está diseñado para su aplicación en instalaciones de aire acondicionado, ventilación o calefacción, con un diferencial de temperatura de hasta 12º C. Dispone de microtoberas orientables manualmente en todas direcciones para instalar en pared o en techo. Difusor construido en aluminio y microtoberas en PP.

Fruto de la colaboración con el estudio **Lievore, Altherr & Molina**, el difusor **KIS** aporta una nueva estética para este tipo de difusores, con líneas más suaves que favorecen su integración arquitectónica.

KIS

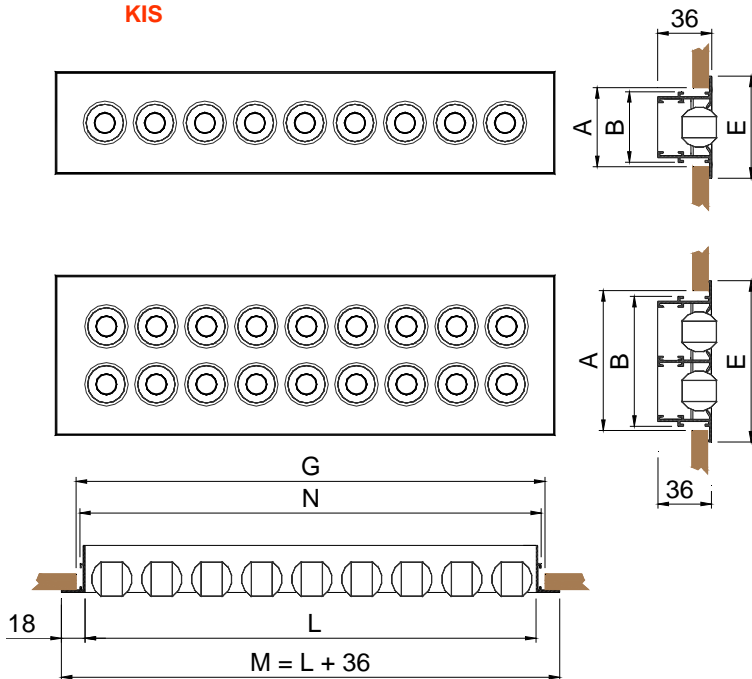

	E	A	B	C
KIS 1	68	55	47	40
KIS 2	107	95	86	80

L	M	N	G
500	536	507	516
1000	1036	1007	1016
1200	1236	1207	1216
1500	1536	1507	1516
2000	2036	2007	2016

CLASIFICACIÓN

KIS-AR Difusor lineal con ángulos de remate incluidos. Disponible hasta 2m de longitud.

...-ARI Difusor lineal con un ángulo de remate en el lado izquierdo. Necesario para formar líneas >2m.

...-ARD Difusor lineal con un ángulo de remate en el lado derecho. Necesario para formar líneas >2m.

...-INT Difusor lineal sin ángulos de remate. Necesario para formar líneas > 4 m.

MATERIAL

Difusor construido en aluminio y microtobera en plástico PP.

ACCESORIOS ACOPLABLES

PLSD Plenum con conexión circular lateral. Incorpora soportes para suspensión en el techo. Construido en acero galvanizado.

...-R Plenum con regulador de caudal en el cuello de conexión.

.../AIS/ Plenum aislado termoacústicamente mediante una espuma con un coeficiente de conductividad térmica de 0,04 w/mk. Dicha espuma cumple con las normas de reacción al fuego:

UNE 23-727 M2

NFP 92-501 M2

DIN 4102 M2

KIS

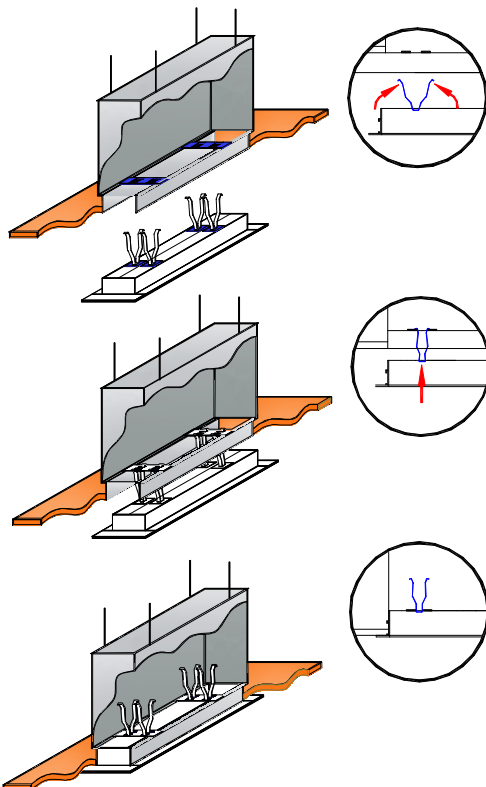
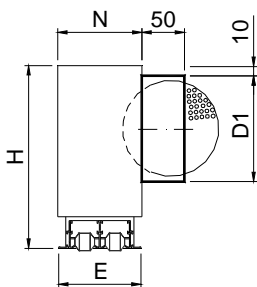
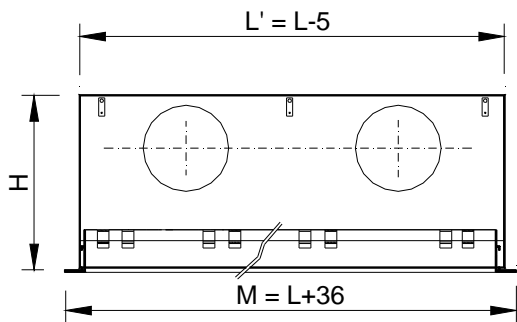

SISTEMAS DE FIJACIÓN

(D) Escuadras para suspensión del techo de KIS o KIS+PLSD.

(PL) Conexión a plenum PLSD+PML mediante clips y suspensión del conjunto al techo. Este sistema simplifica y facilita el montaje y desmontaje del difusor al plenum.

(PM) Puentes de montaje para instalación del difusor sin plenum en falso techo.

ACABADOS

M9016 Lacado blanco similar al RAL 9016. Microtoberas blancas.

R9010 Lacado blanco RAL 9010. Microtoberas blancas.

M9006 Lacado gris similar al RAL 9006. Microtoberas negras.

R9005 Lacado negro RAL 9005. Microtoberas negras.

RAL... Lacado otros colores RAL. Microtoberas blancas o negras.

TEXTO DE PRESCRIPCIÓN

Sum. y col. de difusor lineal con microtoberas orientables **KIS-AR+PLSD-R M9016 1x1000** construido en aluminio y acabado lacado color blanco **M9016** u otro a definir por la D.F. Con plenum de conexión circular lateral, regulador de caudal en el cuello y elementos necesarios para montaje **PLSD-R**. Marca **MADEL**.

	0,5 < L < 1,2		1,3 < L < 1,5		1,6 < L < 2		N	E
	H	D1	H	D1	H	D1		
KIS 1	256	1/158	256	1/158	256	2/158	69	68
KIS 2	256	1/158	256	2/158	256	2/158	108	107

KIS

m	KIS 1	Vmin m/s	Vmax m/s	Qmin m3/h	Qmax m3/h
0.5	0.0024	2.5	6.5	25	57
1	0.0048	2.5	6.5	43	112
1,1	0.0053	2.5	6.5	48	125
1,2	0.0058	2.5	6.5	52	135
1,3	0.0063	2.5	6.5	56	146
1,4	0.0067	2.5	6.5	60	158
1,5	0.0072	2.5	6.5	65	169
1,6	0.0077	2.5	6.5	69	180
1,7	0.0082	2.5	6.5	74	191
1,8	0.0087	2.5	6.5	78	203
1,9	0.0092	2.5	6.5	82	215
2	0.0096	2.5	6.5	86	225

m	KIS 2	Vmin m/s	Vmax m/s	Qmin m3/h	Qmax m3/h
0.5	0.0048	2.5	5.5	43	95
1	0.0096	2.5	5.5	86	190
1,1	0.0106	2.5	5.5	95	210
1,2	0.0116	2.5	5.5	104	229
1,3	0.0125	2.5	5.5	112	248
1,4	0.0135	2.5	5.5	122	267
1,5	0.0145	2.5	5.5	130	286
1,6	0.0154	2.5	5.5	139	305
1,7	0.0164	2.5	5.5	148	324
1,8	0.0174	2.5	5.5	157	343
1,9	0.0183	2.5	5.5	165	365
2	0.0193	2.5	7	174	382

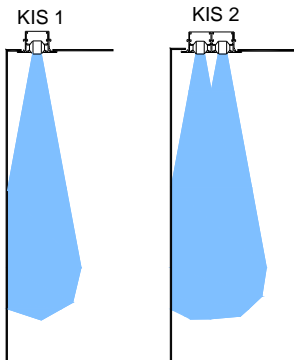
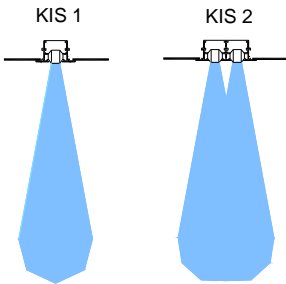

FACTOR DE CORRECCION DEL ALCANCE KL

	0.5 m	1 m	1.5 m	2 m
1	0.71	1	1.07	1.14
2	0.73	1	1.09	1.15

$AL'02 = KI \times AL02$

VELOCIDAD LIBRE, PERDIDA DE CARGA Y POTENCIA SONORA, ALCANCE CON EFECTO TECHO: 1 DIRECCIÓN.

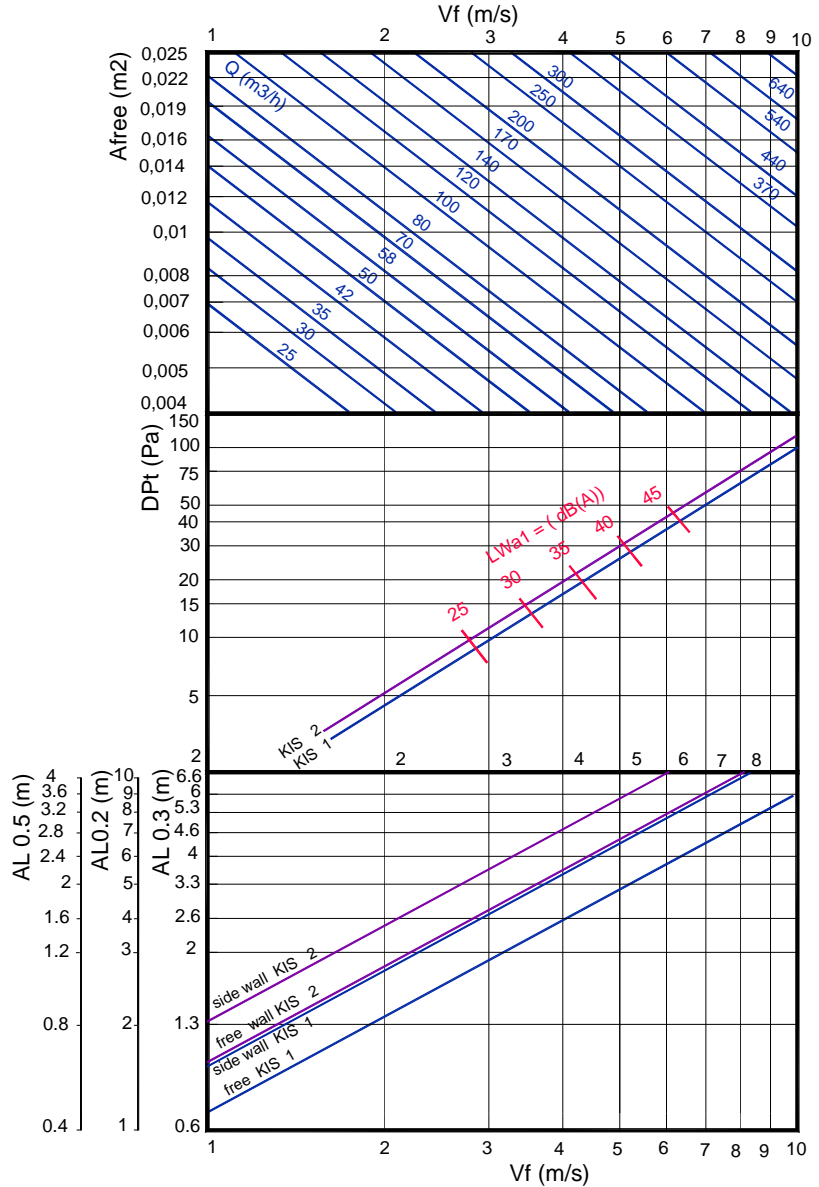

Nota: En MadelMedia Espectro por banda de octava en Hz.

VALORES DE CORRECCION PARA Dpt Y Lwa1.

	0.5 m			1 m			1.5 m			2 m		
	100%	50%	0%	100%	50%	0%	100%	50%	0%	100%	50%	0%
1 Dpt	0.95	2.35	3.15	1	1.4	2.2	1	1.4	2.2	1.1	2.5	3.3
1 Lwa1	-6,1	-3,1	-3,6	0	+0,8	+0,4	+0,9	+1,6	+1	-2,1	-0,5	-1,9
2 Dpt	0.98	2.48	3.25	1	1.5	2.3	1	1.5	2.3	1.2	2.7	3.5
2 Lwa1	-3,8	-3,4	-2,9	0	+0,6	+0,6	+2,4	+3,3	+3,2	-0,3	+0,9	+1,1

$D_{Pt1} = K_p \times D_{Pt}$
 $L_{wa1} = L_{wa} + K_f$

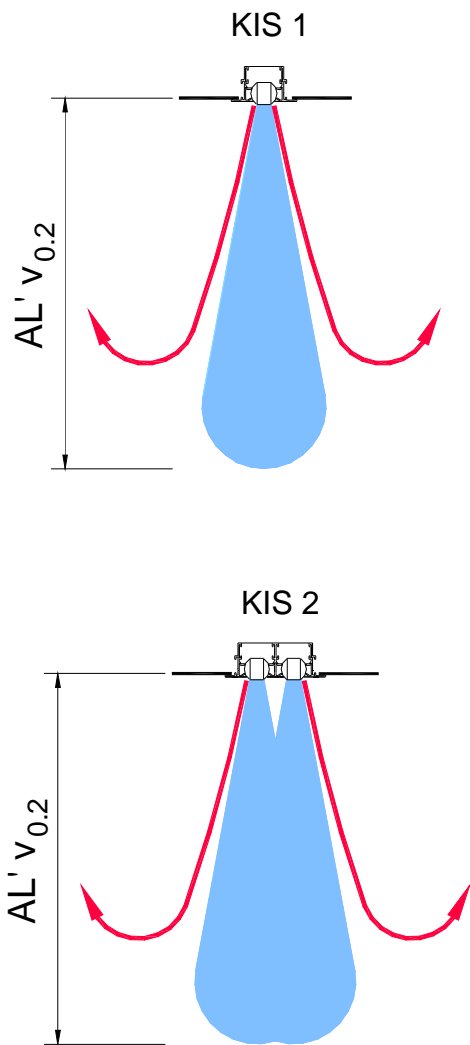

FACTOR DE CORRECCION DEL ALCANCE VERTICAL (ALv 0,2) DT

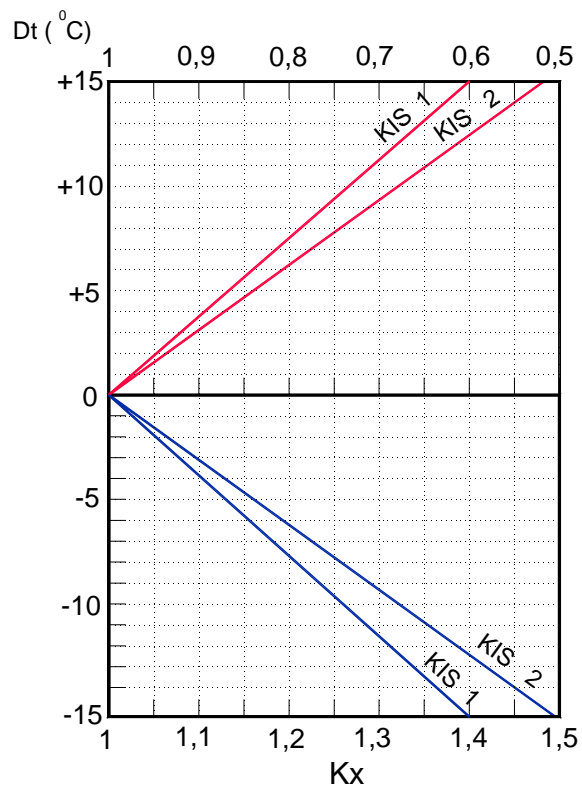

$$AL' v_{0.2} = Kx \times AL_{0.2}$$

KIS

m	KIS 1	Vmin m/s	Vmax m/s	Qmin m3/h	Qmax m3/h
0,5	0.0024	2.5	6.5	25	57
1	0.0048	2.5	6.5	43	112
1,1	0.0053	2.5	6.5	48	125
1,2	0.0058	2.5	6.5	52	135
1,3	0.0063	2.5	6.5	56	146
1,4	0.0067	2.5	6.5	60	158
1,5	0.0072	2.5	6.5	65	169
1,6	0.0077	2.5	6.5	69	180
1,7	0.0082	2.5	6.5	74	191
1,8	0.0087	2.5	6.5	78	203
1,9	0.0092	2.5	6.5	82	215
2	0.0096	2.5	6.5	86	225

m	KIS 2	Vmin m/s	Vmax m/s	Qmin m3/h	Qmax m3/h
0,5	0.0048	2.5	5.5	43	95
1	0.0096	2.5	5.5	86	190
1,1	0.0106	2.5	5.5	95	210
1,2	0.0116	2.5	5.5	104	229
1,3	0.0125	2.5	5.5	112	248
1,4	0.0135	2.5	5.5	122	267
1,5	0.0145	2.5	5.5	130	286
1,6	0.0154	2.5	5.5	139	305
1,7	0.0164	2.5	5.5	148	324
1,8	0.0174	2.5	5.5	157	343
1,9	0.0183	2.5	5.5	165	365
2	0.0193	2.5	7	174	382

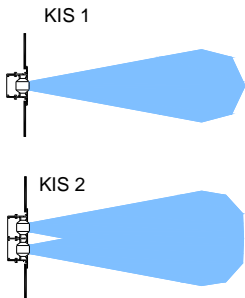
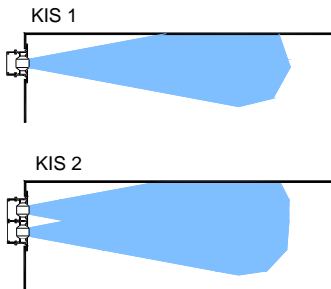

FACTOR DE CORRECCION DEL ALCANCE KL

	0.5 m	1 m	1.5 m	2 m
1	0.71	1	1.07	1.14
2	0.73	1	1.09	1.15

$AL'_{02} = K_l \times AL_{02}$

VELOCIDAD LIBRE, PERDIDA DE CARGA Y POTENCIA SONORA: IMPULSION VERTICAL.

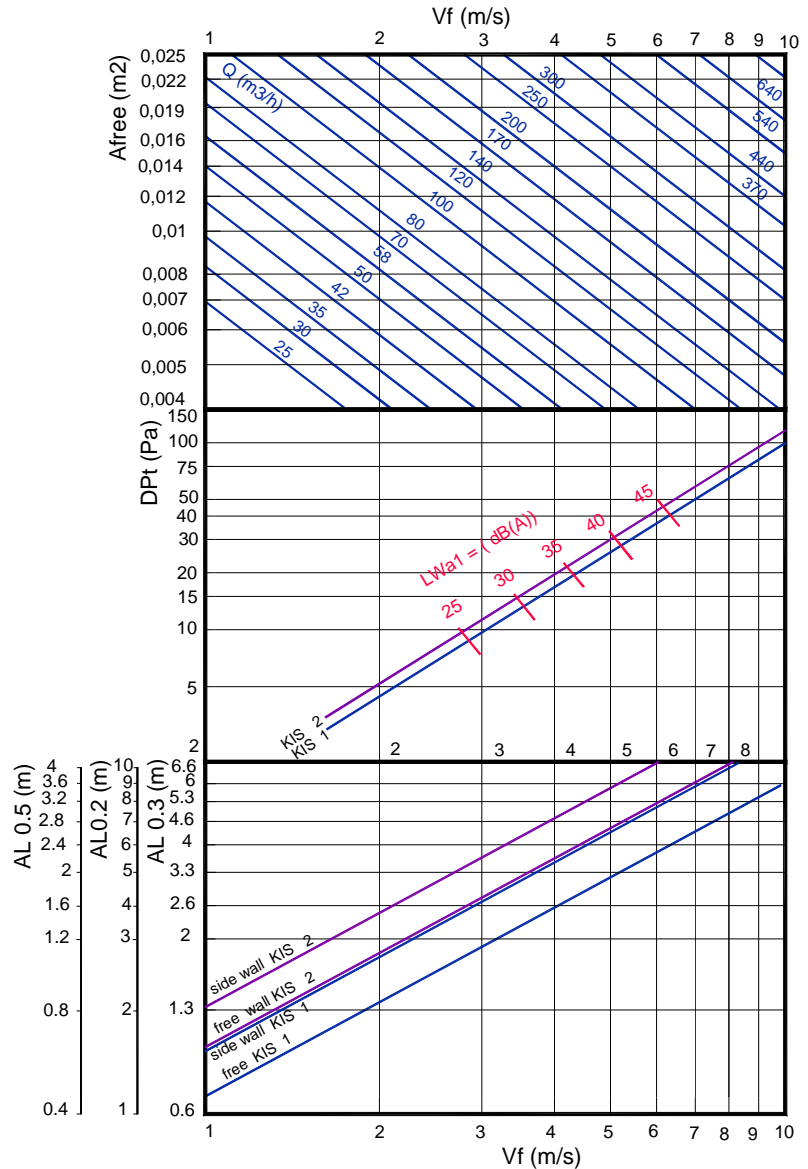

Nota: En MadelMedia Espectro por banda de octava en Hz.

VALORES DE CORRECCION PARA Dpt Y Lwa1.

	0.5 m			1 m			1.5 m			2 m		
	100%	50%	0%	100%	50%	0%	100%	50%	0%	100%	50%	0%
1 Dpt	0.95	2.35	3.15	1	1.4	2.2	1	1.4	2.2	1.1	2.5	3.3
1 Lwa1	-6	-3	-3,6	0	0,8	0,4	+1,2	+1,9	+1,4	-2	-	-1,6
2 Dpt	0.98	2.48	3.25	1	1.5	2.3	1	1.5	2.3	1.2	2.7	3.5
2 Lwa1	-4	-3,6	-3,1	0	+0,6	+0,6	+2,3	+3,2	+3,1	0	+1	+1,2

$Dpt1 = K_p \times Dpt$
 $Lwa1 = Lwa + K_f$

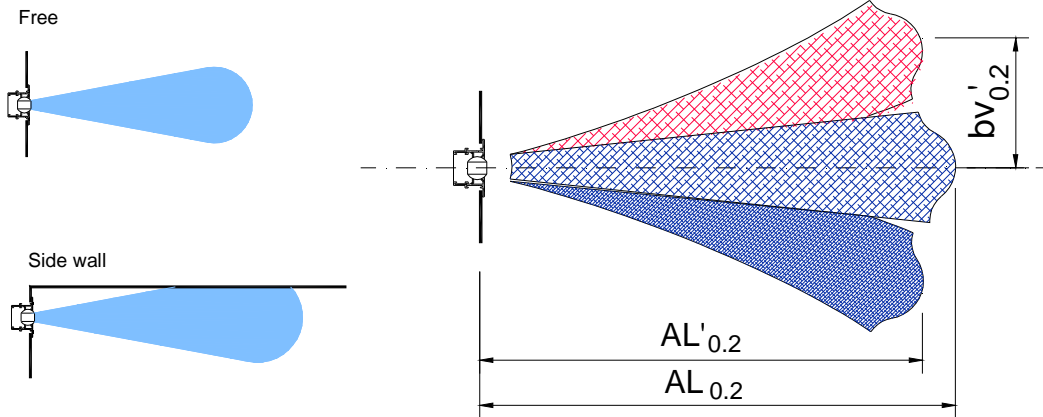

FACTOR DE CORRECCION DE LA DIFUSIÓN VERTICAL (bv) PARA DT (-).

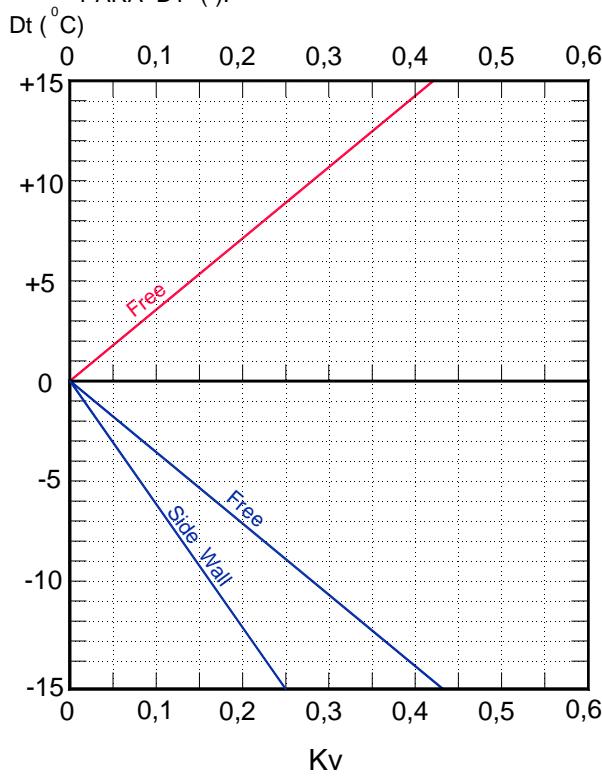

$$bv'_{0.2} = Kv \times Al_{0.2}$$

Kv = Factor de corrección de la difusión vertical.

FACTOR DE CORRECCION DEL ALCANCE (L0.2) DT (-).

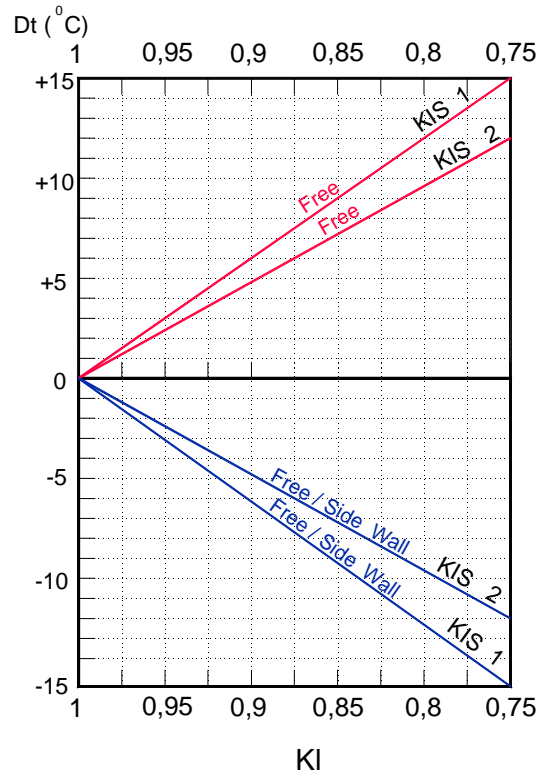

$$Al'_{0.2} = Kl \times Al_{0.2}$$

Kl = Factor de corrección del alcance.

 KIS

m	KIS 1	Vmin	Vmax	Qmin	Qmax
		m/s	m/s	m3/h	m3/h
0,5	0.0024	2.5	6.5	25	57
1	0.0048	2.5	6.5	43	112
1,1	0.0053	2.5	6.5	48	125
1,2	0.0058	2.5	6.5	52	135
1,3	0.0063	2.5	6.5	56	146
1,4	0.0067	2.5	6.5	60	158
1,5	0.0072	2.5	6.5	65	169
1,6	0.0077	2.5	6.5	69	180
1,7	0.0082	2.5	6.5	74	191
1,8	0.0087	2.5	6.5	78	203
1,9	0.0092	2.5	6.5	82	215
2	0.0096	2.5	6.5	86	225

m	KIS 2	Vmin	Vmax	Qmin	Qmax
		m/s	m/s	m3/h	m3/h
0,5	0.0048	2.5	5.5	43	95
1	0.0096	2.5	5.5	86	190
1,1	0.0106	2.5	5.5	95	210
1,2	0.0116	2.5	5.5	104	229
1,3	0.0125	2.5	5.5	112	248
1,4	0.0135	2.5	5.5	122	267
1,5	0.0145	2.5	5.5	130	286
1,6	0.0154	2.5	5.5	139	305
1,7	0.0164	2.5	5.5	148	324
1,8	0.0174	2.5	5.5	157	343
1,9	0.0183	2.5	5.5	165	365
2	0.0193	2.5	7	174	382

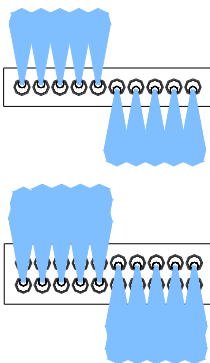
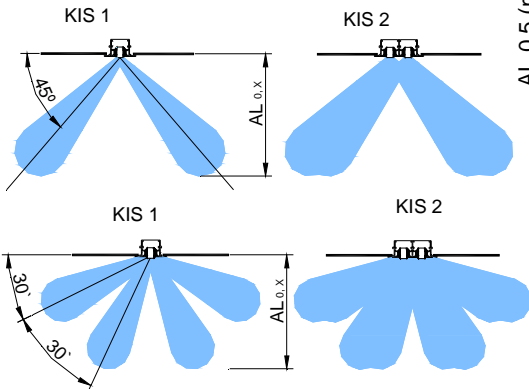

FACTOR DE CORRECCION DEL ALCANCE KL

	0.5 m	1 m	1.5 m	2 m
1	0.71	1	1.07	1.14
2	0.73	1	1.09	1.15

$AL'02 = KI \times AL02$

VELOCIDAD LIBRE, PERDIDA DE CARGA Y POTENCIA SONORA: IMPULSION VERTICAL.

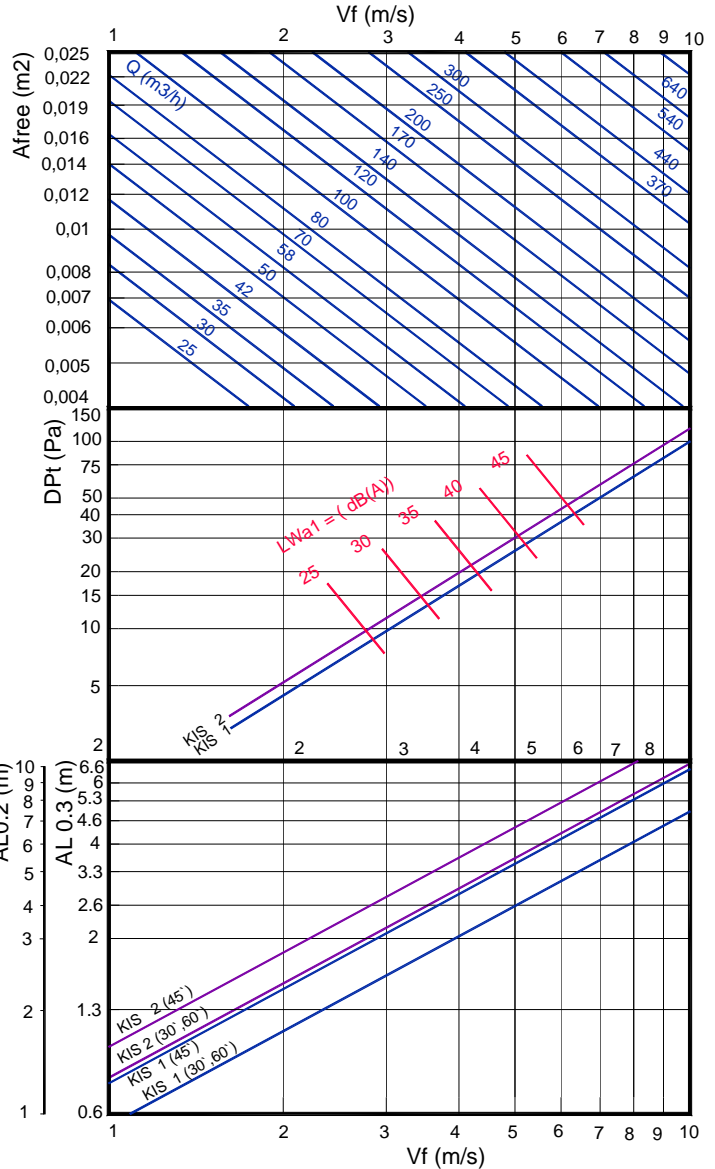

Nota: En MadelMedia Espectro por banda de octava en Hz.

VALORES DE CORRECCION PARA Dpt Y Lwa1.

	0.5 m			1 m			1.5 m			2 m		
	100%	50%	0%	100%	50%	0%	100%	50%	0%	100%	50%	0%
1 Dpt	0.95	2.35	3.15	1	1.4	2.2	1	1.4	2.2	1.1	2.5	3.3
1 Lwa1	-6	-3	-3.7	0	+0.8	+0.4	+1	+1.7	+1.2	-2.1	-0.4	-1.9
2 Dpt	0.98	2.48	3.25	1	1.5	2.3	1	1.5	2.3	1.2	2.7	3.5
2 Lwa1	-3.7	-3.4	-2.9	0	+0.6	+0.6	+2.4	+3.3	+3.2	-0.5	+0.8	+0.9

$Dpt1 = Kp \times Dpt$
 $Lwa1 = Lwa + Kf$

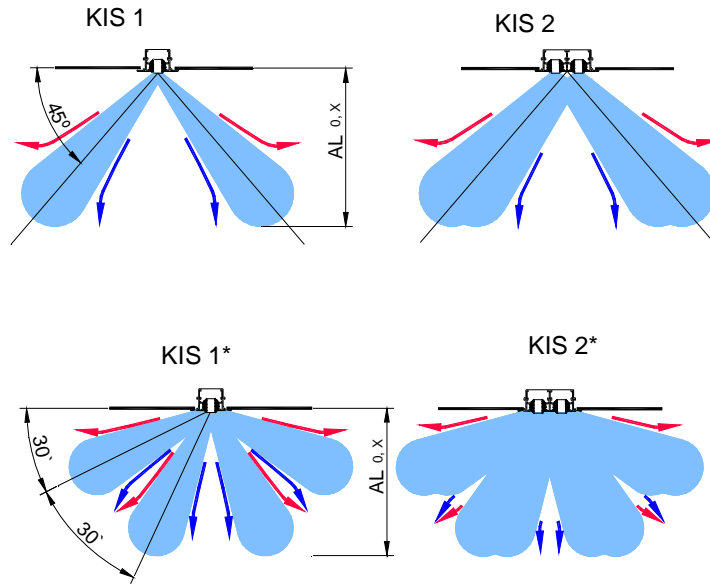

FACTOR DE CORRECCION DEL ALCANCE VERTICAL ($AL_{0,2}$) DT

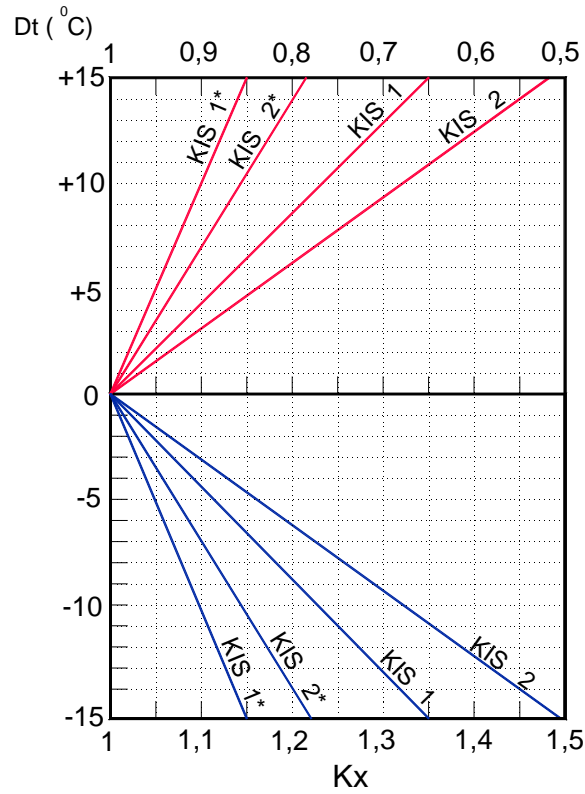

$$AL'_{v_{0,2}} = K_x \times AL_{0,2}$$